

**Towards Integrated Intranet Services:
Modeling the Costs of Corporate IP Telephony**

by
Kristin Ilene Short
B.S. Electrical Engineering
University of Evansville, 1995

Submitted to the Department of Electrical Engineering and Computer Science
and the Technology and Policy Program
in Partial Fulfillment of the Requirements for the Degree of

Master of Science in Technology and Policy
at the
Massachusetts Institute of Technology
September, 1997

© Massachusetts Institute of Technology, 1997.
All rights reserved.

Signature of Author

Department of Electrical Engineering and Computer Science
September 4, 1997

Certified by

Dr. Lee W. McKnight
Lecturer, Technology and Policy Program
Thesis Supervisor

Accepted by

Professor Richard deNeufville
Chairman, Technology and Policy Program

Accepted by

Prof. A. C. Smith
Chairman, Committee on Graduate Students
Department of Electrical Engineering and Computer Science

Towards Integrated Intranet Services: Modeling the Costs of Corporate IP Telephony

by

Kristin Ilene Short

Submitted to the Technology and Policy Program
in Partial Fulfillment of the Requirements for the Degree of
Master of Science in Technology and Policy

Abstract

This thesis addresses the issue of providing Internet telephony communication to every desktop on a company's network in order to handle intra-company voice traffic and data traffic over a single integrated backbone. To understand the costs of providing Internet telephony over an intranet, a model was developed to describe the additional costs to enable the use of Internet telephony over this network. From this model, the incremental cost of providing Internet telephony to all employees is roughly determined. We find that the cost of integrated voice and data lines, at this time, is too great when compared to the cost of traditional telephony to be used to promote the expansion of Internet telephony into the business communication infrastructure. The cost is likely to remain prohibitive until the cost of the technology declines and it requires less support personnel. Issues relevant to the management of such an intranet, issues concerning the telecommunications industry, as well as the wider issue of regulation and Internet telephony are also addressed. Internet telephony has been receiving additional notice from regulators, both in the United States and in Europe. How governments approach Internet telephony will affect its development and use both in the public and private sectors. At this time, the technology is too immature to be considered a threat to the telecommunications industry. In this period of deregulation in the telecommunication industry, regulators are unlikely to impose charges or fees on Internet telephony in the near future. However, regulators must monitor Internet telephony's development and use to ensure that this technology benefits, rather than harms, the public.

Thesis Supervisor: Dr. Lee W. McKnight
Lecturer,
Technology and Policy Program

Acknowledgments

The opinions expressed in this thesis are mine and mine alone. They do not represent the views of the Internet Telephony Consortium, its Member Companies, or the Massachusetts Institute of Technology.

For their support of this thesis, I would like to thank the Center for Technology, Policy and Industrial Development, the Internet Telephony Consortium and its Member Companies: Hewlett-Packard, Lucent Technologies, Media One, Mediatrix Peripherals, Inc., Natural Microsystems, Netspeak Corp., Nokia, Sprint, Telecom Italia, Telenor, and Telia. Industry experts made available to me through the ITC contributed their time and knowledge and I would like to thank them.

The assistance of William Lehr and Sharon Gillett went beyond the call of duty on more occasions than I care to count. And without the support and encouragement of my thesis advisor, Lee McKnight, I could not have finished this.

I'd like to thank my fellow MIT students Andrew Sears, Brett Leida, Donya Krairit, and Jim Wahl of the Research Program for Communications Policy for their support and empathy during all stages of this endeavor. I'd also like to thank Elizabeth Yoon for her support, both mental and secretarial.

I'd like to thank the members of my family for always making me laugh while, often simultaneously, pestering me to finish this thesis.

My sanity would have been completely lost during this project without chocolate and movies. To everyone associated with the production of these fine products, I am eternally grateful.

Table of Contents

Abstract	2
Acknowledgments	3
Table of Contents	4
Table of Figures	5
Table of Tables	6
Chapter 1: Introduction	7
Chapter 2: Model Description	16
Chapter 3: Results and Analysis	31
Chapter 4: Regulation and Internet telephony	42
Chapter 5: Conclusions	57
Bibliography	64
Appendix A: Acronyms	67
Appendix B: Cost Model Input Table	69
Appendix C: Outcomes for Base Scenarios	72
Appendix D: Erlang B Macros by Brett Leida	75
Appendix E: Internet Telephony Consortium European Regulatory Task Force Comment to the European Commission Concerning the Status of Voice on the Internet under Directive 90/388/EEC	77

Table of Figures

Figure 1: Basic Network Architecture-----	25
Figure 2: Equipment Breakdown -----	35
Figure 3: Monthly Costs-----	36
Figure 4: Total Monthly Cost as a Function of Number of Employees -----	37
Figure 5: Total Monthly Cost as a function of Blocking Probability -----	38
Figure 6: Total Monthly Cost as a function of Peak Combined Calls per Hour -----	38
Figure 7: Total Monthly Cost as a function of Average Holding Time -----	39
Figure 8: Total Monthly Cost as a function of Additional Support Time-----	40
Figure 9: Equipment Breakdown -----	58
Figure 10: Monthly Cost Breakdown-----	59

Table of Tables

Table 1: Model Core Assumptions -----	16
Table 2: United States--Establishments, Employees and Payroll: 1994-----	17
Table 3: Business Line Variables -----	19
Table 4: Fax Line Variables -----	20
Table 5: Cost of Capital Variables-----	23
Table 6: Gateway Server Variables-----	28
Table 7: Model Output Variables -----	31
Table 8: End-User Equipment Scenarios -----	32
Table 9: Results for End-User Scenarios -----	33
Table 10: Default results for Scenario A-----	34
Table 11: EU Criteria for Voice Telephony-----	54
Table 12: Results for Base Scenario-----	57

Chapter 1: Introduction

The Internet is a global, packet-switched¹ data network that has primarily been used for data transfer in the form of email, files and more recently world-wide web pages. Yet some unique programs have been written to take advantage of the functionality available through the use of a common network protocol, namely the Internet Protocol (IP). These programs utilize the protocols that allow data to be exchanged from computer to computer, regardless of what kind of machine it is or what platform it runs. These programs perform a set of unique tasks that are not usually thought of as computer tasks—from remote control of robots an ocean away to running toasters to “The Amazing Fishcam.”²

One type of program that has been developed is real-time audio/video communication known as Internet telephony. Internet telephony is an interesting application because it is an obvious convergence of the Internet and telecommunications. As such, it could complement or displace the traditional telecommunications approach to real-time communication in some circumstances. This thesis addresses one of these circumstances—specifically, the possible adoption of Internet telephony as the technology to handle real-time communication within a small company. Wide-spread use of Internet telephony in the work place would require a shift in how business communication is seen and used. This thesis attempts to validate the hypothesis that the adoption of Internet telephony is a cost effective solution for companies

¹ Anything sent over the Internet from one point to another is broken down into packets according to the Internet Protocol. Each packet must individually make its way from its source to its destination. As a consequence of this, packets from the same data may take drastically different routes to reach their destination. Thus, the Internet is a packet-switched network. As a contrast, the public switched telephone network is a circuit switched network, e.g., a network where a continuous connection is dedicated to connect one point to the other for the duration of the call.

that seek an integrated voice/data network. In addition, this thesis also considers the wider issues surrounding Internet telephony and its position in the regulatory environment.

This thesis looks at the process and consequences of providing Internet telephony communication to every desktop on a company's network so that intra-company voice traffic and data traffic are carried over a single integrated backbone. This capability is a necessary step towards providing multimedia collaborative tools to all employees as well as providing other services, such as fax over the net. To understand the costs of providing Internet telephony over an intranet, a model was developed to describe the additional costs to enable the use of Internet telephony over an intranet.³ From this model, the incremental cost of providing Internet telephony to employees was roughly determined.

As a voice service, the regulatory atmosphere surrounding telecommunications must be examined when considering any implementation of Internet telephony. Whether Internet telephony should be considered in the same frame of reference as a basic service or as an enhanced service will affect how this technology is deployed and used. To begin to understand the regulatory issues, the history of telephony regulation is examined to see how the regulatory structure began and how it is changing is detailed in Chapter 4. With this background, the status of Internet telephony under this changing framework is then examined. At this time, the technology is too immature to be considered a competitive threat

² "The Amazing Fishcam"—the second oldest live camera site on the web—can be found at [<http://www2.netscape.com/fishcam/fishcam.html>].

³ This work was done within the context of the Internet Telephony Consortium, a joint business and academic group that works on the technical, economic, strategic and policy issues that arise from the convergence of the Internet and telecommunications. More information on the ITC can be found on their web site [<http://itel.mit.edu>]. The opinions expressed in this thesis belong to the author alone and should not be attributed in any way to the ITC, its Member Companies, or the Massachusetts Institute of Technology.

to the telecommunications industry. Regulatory barriers would be premature and would hinder the development and deployment of this technology.

The rest of this chapter sets up the framework for this thesis in greater detail.

Introduction

Currently, real-time voice communication is carried over the Public Switched Telephony Network (PSTN) as well as private leased lines. In this network, whenever a call is made, a circuit of 64 kHz is dedicated to that call for its duration. When the call is finished, the circuit is released and can be used for other calls. While this network has been optimized to carry voice traffic, it is inefficient in its use of bandwidth. Whenever there is silence over the circuit, in essence, the bandwidth that is dedicated to the call is wasted as a trade-off for having a dedicated circuit for the call duration.

In recent years, some companies have developed software packages that enable real-time voice to be carried over the Internet. These Internet telephony packages compress and translate the analog voice signal into digital.⁴ The digital signal is converted into Internet Protocol (IP) packets and transmitted over the Internet to their destination where the packets are converted into a single digital and then into an analog voice signal. While this technique does not yet provide the same quality of service as a circuit switched network when it operates over the public Internet, the quality has improved significantly since it was first introduced and is comparable to cellular telephone quality. When this software is used over private networks, the quality can improve significantly. Furthermore, by packetizing the voice signal, only the bandwidth that is needed is used to make the call; thus, the bandwidth is more efficiently utilized.

The potential of being able to have real-time voice communication over the Internet has tremendous potential in the long-distance voice market. By having local Internet connections, two people can communicate by voice for the price of a local call—even if they are thousands of miles apart. This ability to bypass long-distance carriers can be used not only by the home consumer, but by companies as well. Companies with offices across countries, as well as across continents, can use their corporate networks and Internet telephony to handle some of their long-distance voice traffic and if used strategically, can lower long-distance bills.

The world of corporate networks is changing, though. Many Chief Information Officers (CIO's) are realizing that they can utilize their local area networks (LANs) and wide area networks (WANs) in new ways by layering a set of Web based technologies over their existing networks.⁵ This implementation creates a corporate intranet. By setting up standards for Web publishing and supplying Web browsers to employees, CIO's can change the way information is exchanged within the company. Intranets have been shown to significantly affect employee productivity for very little cost.⁶ However, CIO's are also discovering that with the wider use of Web technology their networks need to be revamped. Of particular concern is the amount of bandwidth consumed by these products. Through the implementation of an intranet, network traffic can often triple.⁷ To combat this growth in

⁴ A list of available Internet telephony software packages can be found at the Internet Telephony Consortium's web site [<http://itel.mit.edu/software.html>].

⁵ Hills, Melanie. *Intranet business strategies*. New York: John Wiley & Sons, 1997. p. 3-4.

⁶ Productivity has been estimated to increase ten minutes per employee per day. See Gilbbs, Mark. "The Intranet Scale Problem." *Datamation*. Dec. 1996: 38.

Return on investment from the implementation of intranets has been as high as 1300%. See Rush, William and Michael Josephs. "Crank it up." *Intranets*. Feb. 1997: 26-7.

⁷ The Gartner Group estimates that implementing a corporate intranet can triple network traffic. See Kaplan, Jeffery. "Getting intranet-ready is harder than it seems." *Network World*. 2 Dec. 1996.

traffic, CIO's can either increase available bandwidth, impose standards on web pages or both when possible.

Another aspect of using intranets is that they promote increased connectivity. One of the key reasons to use an intranet is to distribute company material that would otherwise be printed, such as employee manuals and information regarding company benefits. To reach all employees with this information, all employees need access to the intranet via computers. Providing access to that many employees is no easy task. When Eli Lilly implemented an intranet, they had to hire extra people just to handle the task of assigning addresses to all the additional computers added onto the intranet.⁸

The use of intranets for collaborative work, especially utilizing multimedia, is another key selling point for implementing intranets. By having employees connected with an effective form of rapid communication can benefit any company. In fact some industry analysts see collaborative tools as the "killer app" of intranets.⁹ But to truly have collaborative, real-time communication, employees must be able to transmit voice in real time from any desk in the company.

What is meant by Internet Telephony

There is some debate over what "Internet Telephony" is. It seems to range anywhere from voice only communication to multi-user, computer-facilitated communication.¹⁰ For this discussion, Internet Telephony is defined as a low-level form of teleconferencing using Internet technology with traffic patterns that, in practice, mimic current voice communication traffic patterns. While the functionality to use Internet Telephony for multi-way

⁸ These extra personal were distributing over 500 addresses a month. See Duffy, Jim. "Eli Lilly cures IP ills." *Network World*. 25 Nov. 1996.

⁹ Morro, David. "Ask Dr. Intranet." *Intranet*. Feb. 1997.

communication and groupware type tools is available, wide-spread use of these tools has not yet occurred. Extensive use of Internet Telephony in the workplace would require a paradigm shift in how business communication is seen and used. Without knowing how this shift might occur, it would be premature to declare that Internet Telephony's advanced functionality would be used X amount by the average worker. It does seem prudent to consider that initially, Internet Telephony usage would mimic telephone usage and that as time progresses, more and more of the advanced functionality would be incorporated. Modeling future multimedia services building upon Internet telephony applications is beyond the scope of this thesis. Thus, for this model, the early stages of Internet Telephony adoption is considered with some capability to expand advanced teleconferencing usage as time progresses.

What is meant by intranet

As with the term Internet Telephony, there are different points of view as to what an "intranet" is. According to *Wired Style: Principles of English Usage in the Digital Age*, an intranet is "A private network within an organization (always lowercase.)"¹¹ The popular usage of intranet refers to a private, packet-switched network or network of networks owned by a company or corporation that uses this internal network for various Internet-type services, such as email, FTP, and WWW. For this model, a similar definition is proposed. The intranet defined here is a private network using packet switching for internal Internet-type services in *a geographically contiguous location*, such as within a single building or on a single floor of a building. Furthermore, the usage of this term implies that the organization

¹⁰ Clark, David. *A Taxonomy of Internet Telephony Applications*. Draft ITC document.

¹¹ p. 50

has a network that has been designed to provide its users with a large amount of bandwidth to the desktop.

The question of using Internet Telephony over an intranet comprised of multiple locations that are not geographically contiguous is an interesting question in and of itself. The key to this question is the strategic utilization of Internet Telephony to take advantage of bypass opportunities to avoid excessive long-distance rates.¹² In the immediate future, this opportunity over wide area networks is the driving force behind business adoption of Internet Telephony. However, this model is focused at addressing a different cost issue—the costs associated with wide-spread deployment and use of Internet Telephony within a business environment.

Why look at this issue

Internet telephony represents a real-time application implemented on a packet-switched network. As such, it is more sensitive to packet delay and congestion than other Internet services, such as email or FTP. When used often and by multiple parties, it also has the potential to overwhelm network resources if the network is not designed to handle this type of traffic load. For a network to handle the potential traffic, it either has to be managed carefully or over-provisioned. Either option could lead to considerable expense. For wide deployment of Internet telephony in a business setting to occur, these costs must be accounted for. Thus, one of the first steps for wide deployment of Internet telephony is to determine the cost to install, manage, and support it.

¹² The costs for an Internet Service Provider to provide Internet telephony to its clients over the Internet is studied and evaluated in the thesis “A Cost Model of Internet Service Providers: Implications for Internet Telephony and Yield Management” by Brett Leida (draft).

By using Internet telephony, a company has an opportunity to integrate its voice and data networks. This integration can simplify the cabling plant and increase utilization of bandwidth capacity. An integrated network also has the potential to reduce maintenance costs by reducing the number of networks by one, as well as simplify moves and changes.

Internet telephony is a developing technology and has significant potential for improvement. However, early adoption of Internet telephony and an integrated network does have its potential problems. Communications is a critical capability for any company. Internet telephony, as of 1997, is an immature technology with questionable reliability and quality.¹³ Public data networks, such as the Internet, are not known for running with the same reliability as the public switched telephone network (PSTN). Quality of service for Internet telephony over a public network also has not met the same standards as can be found with circuit switched voice.¹⁴ Even if a company adopts Internet telephony, it still must interoperate with the PSTN—such equipment exists but only in a limited scope, as of this writing. Internet telephony does not yet have the functionality of current public branch exchange (PBX) equipment.

Yet, for a company or an office park, the quality concerns may not be a great hindrance to implementation since packet delays due to distance would be limited. Rather, delay may arise from limited bandwidth or processing delays. Reliability also has been

¹³ The market niche for Internet telephony as a consumer product has primarily been hobbyists due to its lack of technical maturity. ITC European Regulatory Task Force. “Comment to the European Commission Concerning the Status of Voice on the Internet under Directive 90/388/EEC.” July 1997. p. 3. This author was a member of the ITC European Regulatory Task Force, as well as, lead developer of the comment submitted to the EU. The views expressed in the Task Force’s comment represent the views of the Task Force only and should not be construed as representing the views or opinions of the ITC, the Massachusetts Institute of Technology or any program associated with MIT, or any ITC Member Company not participating on the Task Force. The full text of the Comment is in Appendix E.

¹⁴ The non-deterministic switching use in any IP program offers little chance of approximating real-time voice when used in uncontrolled networks, such as the Internet. ITC European Regulatory Task Force. p. 2.

improving with hardware and software improvements. The technology is likely to improve in the coming years and may overcome some of the functionality difficulties it currently has.

Summary

This chapter has introduced the cost model and set up the basic framework from which it was developed. Following chapters will describe the model in greater detail, examine the results from the base case, and discuss the regulatory issues in greater detail by examining the United States statutory law and current telecommunications regulatory practices.

Chapter 2: Model Description

This chapter describes the cost model that was developed to examine the costs associated with the addition of Internet telephony to a company's LAN. The model was developed through literature review and feedback from the Member Companies and staff of the Internet Telephony Consortium. The following elaborates on the core assumptions, the model, and its base scenario.

Model Scenario

The scenario that the model describes is the addition of Internet telephony to a company or a department's local area network (LAN). The addition of Internet telephony to this network is to handle all internal voice communication, as well as to provide the possibility for the use of more advance Internet telephony applications. The core assumptions that will be explained in greater detail are listed in Table 1.

addition of Internet telephony to existing LAN to handle all voice communication
small sized company—twenty to fifty employees
low bandwidth Internet telephony—approximately 15 kbps bandwidth during conversations
switched 10Base-T to the desktop
use of customer premise gateway server to interconnect to PSTN

Table 1: Model Core Assumptions

Size of Network

The number of users is assumed to be between twenty and fifty users. This range was chosen by examining information from the US Census Bureau regarding the distribution of

business establishments according to number of employees.¹⁵ This information has been reproduced in Table 2. Establishments with twenty to forty-nine employees employed the largest percentage of the US work force. Establishments with greater than twenty and less than fifty employees were not the majority of establishments; the largest segment of businesses employs less than twenty persons. However, when considering the possible sizes of LANs to consider, a larger pool of potential users seems necessary to be able to have a LAN large enough to sustain and handle the potential traffic patterns that could arise from the application of Internet telephony. Thus, the range of twenty to fifty employees was chosen on which to base the model.

	Number of Establishments	% of Total	Number of Employees	% of Total	Payroll, annual (\$1,000)	% of Total
Total	6,509,276	100%	96,733,300	100%	\$2,488,227,882	100%
1 to 4	3,575,704	54.9%	6,135,426	6.3%	\$164,101,934	7%
5 to 9	1,286,260	19.8%	8,492,383	8.8%	\$178,344,082	7%
10 to 19	799,561	12.3%	10,744,707	11.1%	\$236,564,453	10%
20 to 49	526,553	8.1%	15,910,654	16.4%	\$359,957,820	14%
50 to 90	177,946	2.7%	12,226,946	12.6%	\$290,263,223	12%
100 to 249	102,007	1.6%	15,286,020	15.8%	\$379,624,972	15%
250 to 499	25,669	0.4%	8,761,877	9.1%	\$241,218,848	10%
500 to 999	9,766	0.2%	6,662,549	6.9%	\$202,278,131	8%
100 or more	5,810	0.1%	12,512,738	12.9%	\$435,874,419	18%

Table 2: United States--Establishments, Employees and Payroll: 1994¹⁶

User Assumptions

Another assumption that is made, is that the LAN is often used as an intranet, that is, all employees are often accessing the Internet or often utilizing web-based applications. This

¹⁵ The size of the establishment by number of employees was determined by examining the County Business Patterns for the United States for the year 1994—the latest year available from the US Census Bureau. See US Dept. of Commerce. *County Business Patterns, United States*. Gov. doc. CPB-94-1. Table 1b. This information can be found at [<http://www.census.gov/prod/2/bus/cbp94/cbp94-1.pdf>].

usage assumes that these applications are bandwidth intensive and require the network to have a large backbone and sufficient bandwidth supplied to every desktop. This usage also assumes that the company has taken the point of view that all employees have access to a desktop PC. However, the users are not seen as intensive users. Intensive users refer to users who have constantly high demands for bandwidth and processing time, such as engineering departments or graphical arts groups. The demand by the users is seen as high, at times, but is not as constant as the intensive users.

In the usage of Internet telephony, the users are seen as not deviating from current business usage patterns. Internet telephony as a technology has yet to become mature and stable. Also, it is uncertain how the usage of Internet telephony would affect the way business communication occurs. So, it seems safe to assume that Internet telephony usage, during its initial adoption, would mimic current business telephone usage.

The effect of Internet telephony usage on the network is examined in the next section. However, this usage must be considered when choosing how many lines to the PSTN to have. Three variables must be determined to find the number of lines to have. These variables and the default values are shown in Table 3.

blocking probability per number of lines: probability that a caller receives a busy signal when he/she calls;

peak combined calls per hour: maximum number of calls received during any hour over the course of a day;

average holding time: the average length of a phone call in minutes

¹⁶ US Dept. of Commerce. *County Business Patterns, United States*. Gov. doc. CPB-94-1. Table 1b.

blocking probability per number of lines	1% ¹⁷
peak combined calls per hour	20 ¹⁸
average holding time (min)	2 ¹⁹

Table 3: Business Line Variables

When the values for these variables are determined, they can be used in the Erlang B formula to determine the number of lines.²⁰ The Erlang B formula is a case of the general network loss formula. By knowing the blocking probability for the number of lines, the peak combined number of calls to arrive in an hour, and the average holding time per call, the number of incoming lines can be calculated through an iterative process. Appendix D has the complete code for the macros that were used in this model—these macros were written by Brett Leida.

For the number of fax lines, these Erlang B macros were also used. The input parameters were changed to reflect likely fax traffic. Thus, for more intensive fax usage, more lines would result. Table 4 shows the fax values that were used.

blocking probability per number of lines	1% ²¹
peak combined calls per hour	3 ²²
average holding time (min)	1 ²³

Table 4: Fax Line Variables

¹⁷ The default blocking probability is set to a low value (1%) because it is assumed that for the business to succeed, potential clients/customers need to be able to reach the company's employees.

¹⁸ The default value was determined by using the Erlang B formula and the assumptions that a small business with approximately fifty employees would have four voice lines, a blocking probability of 1%, and an average holding time of two minutes. The four voice lines assumption arose from Micom's web page for its Voice over IP product; on one of the information pages, Micom lists an office with fifty employees needing a four voice channel system.

¹⁹ The average length of a business phone call was reported in *Newsweek* as being two minutes in length. "Busy, Busy." *Newsweek*. 31 March 1997: 10.

²⁰ The Erlang B formula is a case of the general network loss formula. With the assumption that calls will arrive in a Poisson distribution, the Erlang B formula can be used to approximate the traffic to determine the number of business lines needed. A discussion of the Erlang B can be found in most texts concerned with telecommunications traffic. See Griffiths, J. M., ed. *Local Communications 2: into the digital era*. London: Peter Peregrinus Ltd., 1988. See Leida, Chapter 3 and Appendix 2.

Internet telephony and Network Utilization

The effect of Internet telephony running on a network is dependent on its overall usage. One way to understand usage on any network is to measure its utilization. Utilization is a measure of activity on the wire—it's measured as a percent of time which the wire has any kind of activity on it, whether it's actual data sent or any of the control signals that are sent to acknowledge the status of the wire.²⁴ In this model, Internet telephony is seen as a low-bandwidth application, i.e. one that creates a signal on the wire of less than 20 kbps.²⁵ While this may be a fairly constant stream during the course of a conversation, it does not monopolize bandwidth as downloading graphics can. Internet telephony at this rate could be comparable to downloading web pages of text.

However, the effect of Internet telephony in this switched desktop network would be most noticeable when the signals are aggregated on the backbone.²⁶ For example, assume that Internet telephony software compresses the voice to a digital signal of approximately 15 kbps (with overhead).²⁷ If the twenty users connected to the same switch are each using an Internet telephony application, then an aggregate signal of 300 kbps would be present on the backbone. If only the Internet telephony software is creating traffic on the backbone, over the

²¹ The default blocking probability is set to a low value (1%) because it is assumed that for the business to succeed, potential clients/customers need to be able to reach the company's employees.

²² The default value was chosen under the assumption that the company would receive significantly fewer fax calls per hour than voice.

²³ The average length of a business phone call was reported in *Newsweek* as being two minutes in length. "Busy, Busy." *Newsweek*. 31 March 1997: 10.

²⁴ Breyer, Robert, and Sean Riley. *Switched and Fast Ethernet: how it works and how to use it*. Emeryville, CA: Ziff-Davis Press. 1995. p. 108.

²⁵ kbps = kilo-bits per second; a measure of wire speed

²⁶ The switch itself is likely to have sufficient backplane capacity to handle the switching load among its input ports since it is unlikely that all the input ports would require full wire speed at the same time. With this in mind, the next level where Internet telephony usage would be noticed would be when it is aggregated on the backbone. See "Comparing LAN switch contenders: beyond performance" by Kevin Tolly. [<http://www.xylan.com/STUDIES/NETWORLD/960701.HTM>].

²⁷ Every Ethernet packet includes data, preamble, source and destination addresses, length field and error checking. Everything that is not data is overhead. See Breyer, p. 108.

100 Mbps segment, the utilization would be 0.30%. Thus, for a small group of users with switched 10 Mbps to the desktop connected to a 100 Mbps backbone, there appears to be ample bandwidth for using Internet telephony software, especially if the network has been sized appropriately prior to the addition of Internet telephony.²⁸ In the switched environment proposed, there also would appear to be sufficient bandwidth to handle initial growth of bandwidth consumption that may occur as more advanced Internet telephony applications begin to be used.

*Cost of Capital*²⁹

When a company purchases equipment, it pays a one-time fixed cost for that equipment. However, the purchase of that capital is an investment in the company. Over the course of time and through use, the value of that investment will decline until the equipment is essentially worth nothing. Also, when looking at the capital investment, eventually the equipment will need to be replaced. This depreciation of the equipment and its eventual replacement can be used to amortize the cost so that the company can account for the equipment cost as a monthly expense.

When determining the monthly cost of the equipment, whether there has been any kind of discount from the vendor needs to be determined. What the discount is often depends on the vendor, the type and quantity of equipment and the purchasing agent's skills. A discount factor is included in the model. The model has variables to select whether the

²⁸ A switched Ethernet network can operate up to 100% utilization since it provides a dedicated amount of bandwidth to each device connected to it. A shared Ethernet often cannot operate above 40% utilization due to packet collisions. However, the network must be designed properly to avoid bottlenecks at often demanded devices and servers. Bottlenecks can significantly reduce network efficiency and create network congestion. Breyer, p.109-112.

²⁹ This section was primarily drawn from the "Lecture Notes on Production, Cost, and Demand," Section 4.2, by Prof. Robert S. Pindyck for the Microeconomics course, 15.010, at MIT.

discount factor is used or not for equipment sub-categories. In the base scenario, the discount is taken for all but the gateway server—the purchase of one server is unlikely to receive any significant discount whereas the purchase of fifty software packages is likely to receive a discount. The default value for the discount is twenty percent; this value can be changed on the model input page.

Once the actual cost of the equipment is determined, this value is added to the cost to install the equipment to find the total fixed cost. This cost is then converted into a monthly cost by finding and applying the cost of capital to the total value. The cost of capital is a weighted average of equity and debt that when multiplied by the market value of the capital results in the opportunity cost of owning the capital—the values for the cost of capital and its associated variables can be found in Table 5. Once this cost is determined, when divided by the economic life of the equipment, the monthly cost of owning the equipment is found.

The cost of capital is from the equation:

$$\text{Cost of Capital} = (DE/DE+1)(\text{cost of debt})+(1/DE+1)(\text{cost of equity})$$

DE : debt-equity ratio or debt percent; a ratio of a company's debt to its value in equity

cost of debt: the return a company gives on its long-term bonds

cost of equity: the return expected on equity; found using the Capital Asset Pricing

Model (CAPM) which uses the following equation:

$$\text{cost of equity} = r_f + \beta (r_m - r_f)$$

r_f = risk-free rate of return

β = covariance of the company's stock with respect to the overall stock market

r_m = average rate of return of the market

r_f	5.3% ³⁰
$(r_m - r_f)$	8.4% ³¹
β	1.5 ³²
DE or Debt Percent	30% ³³
Cost of Equity	17.9%
Cost of Debt	9%
Cost of Capital	15.2 ³⁴

Table 5: Cost of Capital Variables

Costs Included in Model

Decisions had to be made concerning what was going to be included in the cost model and what would not. For a network of this size, there are many ways which it can be configured. The choices in the various kinds of hardware and software are dependent on the kinds of traffic and the kinds of tasks to be completed as well as the preference of the network administrator and his/her plans for future development. While the choices for bandwidth will be directly affected by the traffic generated by the use of Internet telephony, the choices for the size of servers will not be directly affected if the Internet telephony applications are operated off of a separate server that is included in the cost model or operated off of the individual PC's in the network. If the costs of components that are not directly affected by the use of Internet telephony applications are included in the cost model, the results of the model could be skewed if the costs varied significantly.³⁵ Also, proprietary

³⁰ The risk-free rate of return is set to the expected return on a one-year Treasury Bill. For the week of August 25, 1997 that return was 5.3%. WSJ: 26 August 1997 p. C16.

³¹ Brealy and Myers's *Principles of Corporate Finance* use 8.4% for the expected rate of return of the market.

³² The covariance can be found in Merrill Lynch's *Security Risk Evaluation* (Beta Book). This value varies for different companies in different fields. The value of 1.5 was chosen to represent a company that has some amount of risk.

³³ This value was arbitrarily chosen.

³⁴ Calculated from given values.

³⁵ For example, the costs associated with the cabling plant will vary greatly from site to site. While the day to day operating costs of the cabling plant will be rather low (if the cost of the cabling plant is annualized over a ten year period), the installation costs can be significant in some cases and not so significant in other cases

cost models already exist that can account for the costs of setting up and operating an LAN. With this in mind, the model has been developed to include the costs of components that would be needed to be added to the network because of the use of Internet telephony.

The cost model is based on the network configuration shown in Figure 1. It consists of a central Fast Ethernet switch or hub connecting to various servers and a set of desktop Ethernet switches.³⁶ Each desktop Ethernet switch then connects to each employee's desktop PC providing a wire speed of 10 Mbps.³⁷ Each PC also has some kind of Internet telephony interface—either a headset with a microphone or a special card that allows a phone to be plugged into the computer. Telecommuters can access the Internet telephony system through the use of software on their remote computers. They connect to the company's LAN through the company's Internet connection by dialing up an Internet Service Provider (ISP). The additional costs associated with the running of Internet telephony applications on this network would arise from the addition of Internet telephony interface devices to each PC, the use of a desktop Ethernet switch rather than a hub, the additional Internet telephony software, the use of a gateway server to handle incoming and outgoing calls, and the additional operational and installation costs.

depending on the building it's being installed in and the difficulty of the cabling run. Since the assumption has been made that the network is going to be put in place or is already in place, regardless of whether Internet telephony is used or not, the inclusion of the cabling plant costs in the Internet telephony over the LAN cost model does not seem necessary since the majority of the costs of the cabling plant cannot be directly attributed to the use of Internet telephony.

³⁶ "Hubs connect network components together, providing a shared connection to the nodes (unlike a switch, which is a device that gives individual PCs a dedicated connection to a server or other resources." David R. Lambert. "Perfect networks: hub & adapter." *PC Magazine*. July 1997: 159.

³⁷ 10 Mbps = 10 Million bits per second; "Mbps" is a measure of the speed at which bits flow

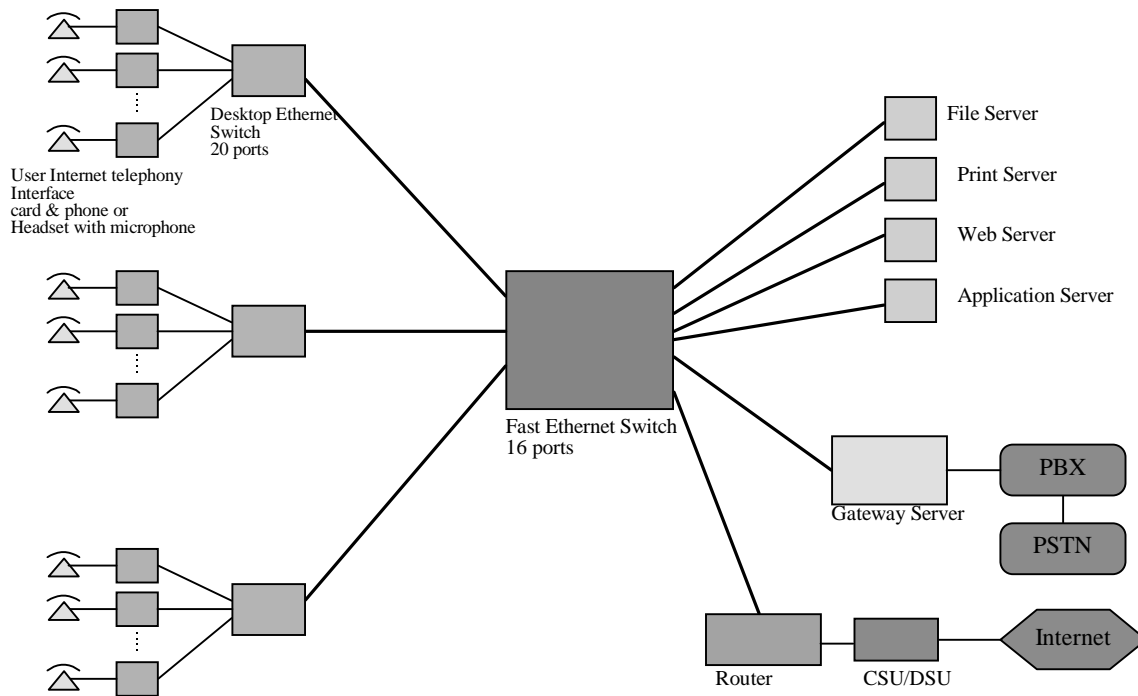

Figure 1: Basic Network Architecture

A decision had to be made between the use of a shared medium or a switched medium to the desktop.³⁸ At this time, 10BaseT is the technology most often deployed to the desktop.³⁹ But, in a shared environment, Internet telephony to shared 10BaseT could prove problematic, especially if the usage of Internet telephony should increase due to increased demand or higher bandwidth applications. In a switched environment, 10BaseT seems like a reasonable solution to the desktop if it has a sufficiently fast backbone. With switched Ethernet to the desktop, after overhead, the end user would still have a data throughput of approximately 7 Mbps—a figure adequate for most current network applications.⁴⁰ The model has included the assumption that a switch is being used in place of a hub because of

³⁸ In shared Ethernet, users and devices connected to the same hub have to share bandwidth among them. For example, twelve users connected to a single 10Mbps hub must share the 10Mbps bandwidth. In a switched environment, a switch is installed in place of the hub. This switch then supplies each user or device connected to it with a dedicated 10Mbps connection. See Breyer. p. 20.

³⁹ Breyer, p. 1.

the use of Internet telephony applications.⁴¹ The costs associated with replacing a hub with a switch have been included—appropriate choices on the User Inputs page can also adjust the costs if the switch is already in place.

End User Interface

Two options are considered for the user interface; each option requires a slightly different method of implementation. The first is the use of a headset with a microphone and a sound card. These items are commercially available at competitive prices and average values have been set as the default values in the model. This option is an appropriate interface for most commercial Internet telephony products. The second option is the Audiotrix Phone by Mediatrix.⁴² This commercially available Internet telephony product includes the hardware and software components necessary for Internet telephony applications all in one package. The end-user configuration schemes are described in greater detail in Chapter 3.

Internet Telephony Software

Commercially available Internet telephony software includes many of the telephony features available on the PSTN. These features include voice mail, call holding, call waiting, muting, blocking, caller ID, conferencing and transferring. Many packages also include features such as whiteboarding and document sharing, call screening, file transfer and text chat.⁴³ For this model, it was assumed that the company would choose a commercially available Internet telephony package that includes the features of real-time voice

⁴⁰ Breyer. p. 113.

⁴¹ The default value for the cost of the switch has been set to the list price for BayNetworks's Desktop Ethernet Switch. Similar switches are also produced by Cisco and Hewlett-Packard.

⁴² More information on the Audiotrix Phone can be found at [<http://www.mediatrix.com/atphone.htm>].

communication, voice mail, call holding, conferencing, call transferring, muting, file transfer, and text chat.

Ideally, licenses would be available that would enable *X* users to run Internet telephony applications for voice and/or other telecommunications uses off of a local server. However, these software packages are not available at this time. Thus, to run Internet telephony applications to communicate between PC users, Internet telephony software must be installed on each PC. To enable PC users to call PSTN users, additional hardware and software in the form of an Internet telephony gateway server are needed. So it seems that the Internet telephony software would run in two pieces—one piece handling calls through the gateway and a second piece of software handling the calls that do not require the gateway. Internet telephony software costs in this scenario would be a multiple of the number of users attached to the system plus the cost for the gateway. The model has included a scenario that attempts to account for a situation where Internet telephony software for *X* clients would exist.

The Gateway Server

A gateway server is needed to handle incoming and outgoing calls. Without this server, a separate phone network would be needed to handle communication between the PSTN and the office. The gateway server is a computer that has been set up with the hardware and the software needed to convert packetized voice into a signal that can be handled by the PSTN. The gateway also has the capability to convert the PSTN signal into IP packets that can be used by the Internet telephony software.

⁴³ More information on two of the leading Internet telephony software vendors products can be found on their web pages: VocalTec [<http://www.vocaltec.com/iphone4/ip4.htm>] and Netspeak [<http://www.netspeak.com/>].

For this model, the gateway has been based on the VocalTec Telephony Gateway System. This is a modular system that begins with a server that meets the requirements for processing speed (greater than 166 MHz for most setups), the right type and number of expansion slots, and memory (40 MB or more).⁴⁴ To this, the gateway software, fax software, Dialogic Boards for connecting to the business lines, and fax modems for connecting to the fax lines are added. As demand grows, this system can be expanded through the addition of more hardware and software. The costs used in this model are based on market place prices for the server and modems and list prices for the equipment and software from VocalTec. The default values are listed in Table 6.

Internet telephony software cost per voice line	\$1,350
Internet telephony software cost per fax line	\$995
cost per Dialogic board	\$600
cost per fax modem	\$150
server	\$3,000

Table 6: Gateway Server Variables

The number of lines for voice and fax is determined through the application of the network loss formula as described in the User Assumptions section.

Installation Costs

A significant amount of time will be necessary to install all of this hardware and to configure it to work properly over the network. To handle this, the model has been set up to take in figures for the amount of time to install each of the components. This number is then multiplied by the number of components to install and then multiplied again by an hourly wage currently set to \$25/hour. For example, to install the sound boards in all the PC's will

⁴⁴ Additional system requirements can be found at VocalTec's Telephony Gateway page at

take approximately an hour for each board which translates into \$25/hour/board. The hourly wage and the amount of time to install each component can be adjusted in the model. Also, if some components are already present in the network (for example, the PCs come with pre-installed sound boards) then the values can be set to zero to remove this cost from further consideration.

Operational Costs

Operational costs would include several things. First, the software and hardware in the network will require some amount of basic maintenance to ensure proper function. This maintenance cost is a percentage of the equipment costs, i.e. 20% of the equipment costs. Additional network support personnel will also be needed to handle the additional maintenance and upkeep of the new network as well as any adds or changes to the Internet telephony system. Also included in the operational costs is the monthly fee charged for the business lines.

The costs of an additional person (or portion of a person) is a salary (or portion of a salary) of \$50,000/year. It is assumed that this salary figure includes any benefits, taxes, etc. that the company must pay for this employee or contractor. Given the amount of additional hardware and software that must be installed and maintained; the fact that communication is a mission critical function; and that during its initial stages of use, there will be adjustments that need to be made to the network; the default value for the number of operations persons has been set twelve hours per week. This figure translates to a day and a half of work per week on Internet telephony applications or fifteen minutes support per employee desktop for fifty employees..

[http://www.vocaltec.com/products/gtw/gtw_requirements.htm].

Summary

This chapter has described the cost model and the assumptions on which it was based. It presents the network architecture and the options available for the types of equipment. It also looked at the annualized costs, the installation costs and the operational costs for running this network.

Chapter 3: Results and Analysis

This chapter discusses the results and analysis of the cost model described in the previous chapter. The chapter begins by introducing the result variables of the model. The results for the base scenario are then presented. Finally, the sensitivity analysis performed on key input variables is presented.

Result variables

Table 7 shows the output variables for the cost model. All output variables are in terms of monthly costs. The model also calculates the Total Equipment Cost (before annualization) as well as the yearly costs for all the variables in Table 7.

Subtotal for Employee Stations
Subtotal for Infrastructure
Annualized Equipment Cost
SW/HW Maintenance
Personnel
Business Lines
Monthly Operations Cost
Total Monthly Cost
Cost / Employee / Month

Table 7: Model Output Variables

Subtotal for Employee Stations: the annualized equipment costs associated with outfitting each employee's desktop computer with the hardware and software necessary to perform Internet telephony

Subtotal for Infrastructure: the annualized costs for setting up the gateway server and converting the network to switched Ethernet to the desktop

Annualized Equipment Cost: the monthly total spent on equipment

SW/HW Maintenance: Monthly amount budgeted for software and hardware maintenance; equals a percentage of the monthly equipment cost

Personnel: monthly salary for the operations person (or portion of a person) responsible for Internet telephony support

Business Lines: The monthly cost of the business lines to the nearest local central office in order to connect the LAN to the PSTN via the gateway server

Monthly Operations Cost: the total amount spent on maintenance, personnel and business lines

Total Monthly Cost: the total spent on equipment and operations per month

Cost/Employee/Month: the Total Monthly Cost divided by the number of employees served by the Internet telephony/data network

Configuration Scenarios

Three different end-user configuration scenarios are presented in the model. These scenarios differ in the types of end-user equipment that is used.

A	Headset with separate software package per PC
B	Headset with server run software
C	Audiotrix Bundle

Table 8: End-User Equipment Scenarios

Scenario A describes a situation which can be implemented today. Each employee's computer is outfitted with a commercially available Internet telephony package, a sound board, and a headset with a microphone. Each of the pieces is purchased separately.

Scenario C is similar to A, except that it uses a bundled Internet telephony product from Audiotrix that provides software, audio board, and a handset all in one package. The third

scenario, B, uses the same user interface as A, but assumes that Internet telephony software to

support X clients is run off a server—this eliminates the cost to install the software on every PC.

As can be seen from the previous paragraphs, the only difference between the three end-user equipment scenarios is the implementation of the equipment on the individual desktop PC's. The mathematical relationships for the rest of the equipment remains the same, regardless of the end-user set-up. As can be seen in Table 9, the costs for the three scenarios differs slightly due to the differing equipment and installation costs. Since there is so little difference in the resulting costs due to differences in the implementation of the end-user equipment, the rest of this chapter will detail the results and analysis for Scenario A only. Full results for all the Configuration Scenarios can be found in Appendix C.

Scenario A	\$60.23
Scenario B	\$59.27
Scenario C	\$64.17

Table 9: Results for End-User Scenarios

Over time, the most likely scenario for Internet telephony implementation is that of Scenario B, where the software for running the application is located on a server. While this would be the ideal situation, at this writing, this kind of software package is not commercially available. Rather than focus on the speculated cost for such a software package and its implementation, this thesis focuses on a scenario that is dominant at this time and for the near future.

Base Scenario Output

Table 10 shows the output for Scenario A when all the default values are entered. The results show that the cost per employee per month for the provision of Internet telephony over LAN is \$60.23.

Subtotal for Employee Stations	\$472.60
Subtotal for Infrastructure	\$725.31
Annualized Equipment Cost	\$1197.92
SW/HW Maintenance	\$239.58
Personnel	\$1302.08
Business Lines	\$272.00
Monthly Operations Cost	\$1813.67
Total Monthly Cost	\$3011.58
Cost / Employee / Month	\$60.23

Table 10: Default results for Scenario A

Equipment Breakdown

Figure 2 shows the monthly cost for equipment and software broken down into the various cost components. The model input variables were set to their default values as described in Chapter 2. (Appendix B contains a copy of the model’s input table with default values entered.)

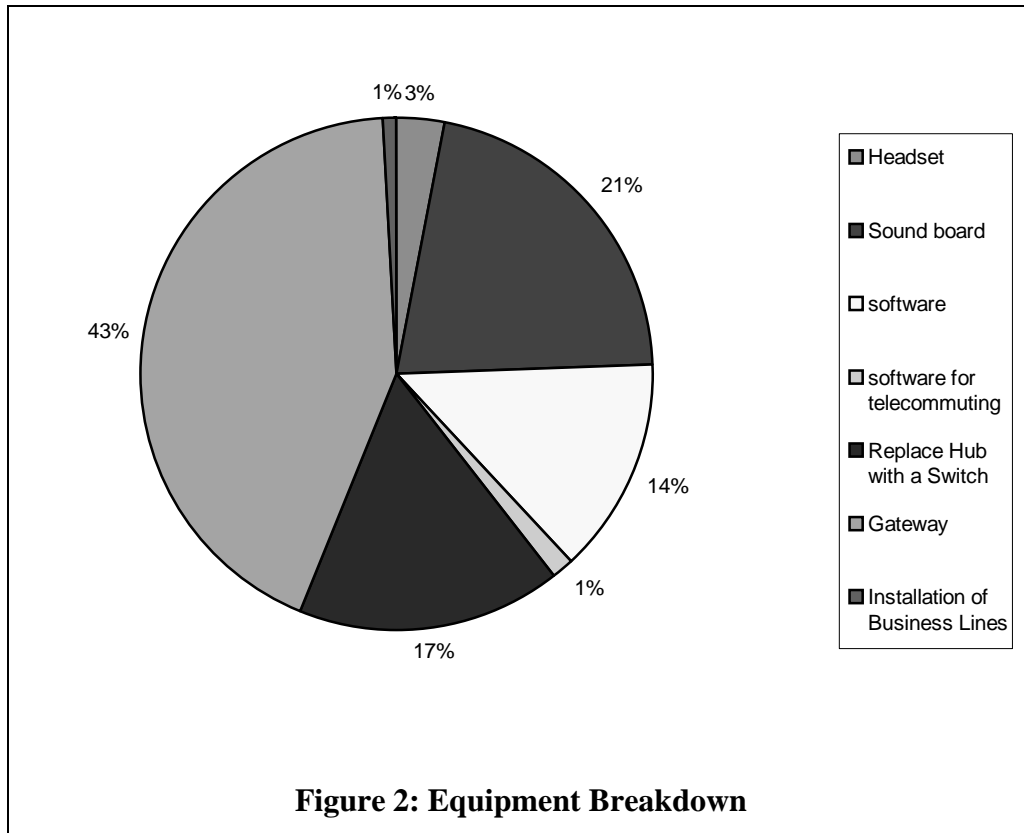

From Figure 2, it is apparent that the bulk of the monthly cost for providing the equipment for Internet telephony stems from the provision of the gateway server. It should also be noted that, when combined, the End-User equipment (including headset, sound board, and software) contribute an almost equal amount to these costs.

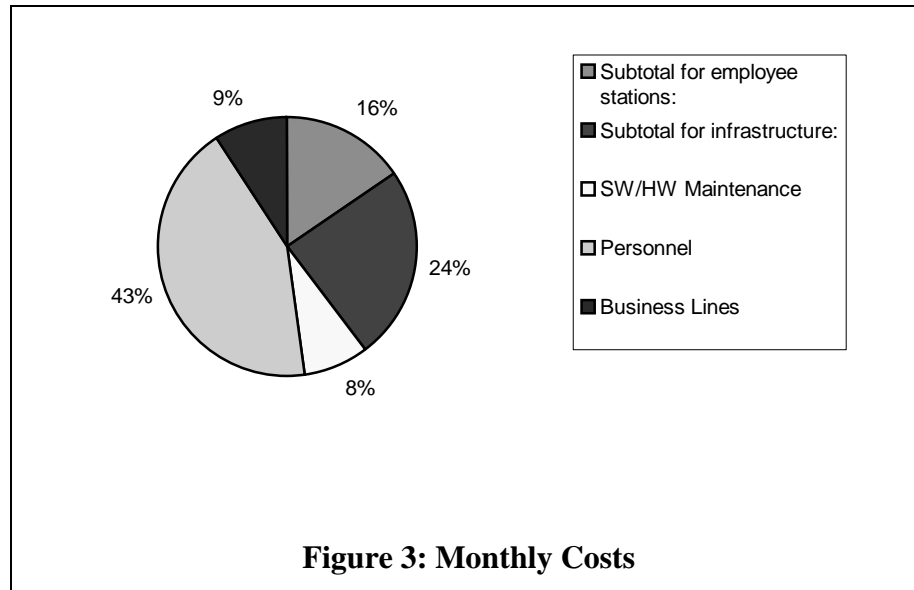

The breakdown of the Monthly Costs is shown in Figure 3. As can be seen, the Personnel Costs comprise the majority of the monthly costs. This results from significant amount of support incorporated into the model. However, because voice is a mission critical resource for any business, higher-levels of support will be necessary until Internet telephony matures as a technology.

Sensitivity Analysis

This section examines how the output variable of monthly cost is affected by variations in the input variables. To see the effect, one variable is changed while the other variables remain set to the default values. The variables and analysis that follows focuses on the variables that result in non-linear responses. The other variables that are not presented, when varied, result in straight line linear changes proportional to the amount of change. The variables examined here are number of employees, blocking probability for number of lines, peak combined calls per hour, average holding time, and additional support time per employee.

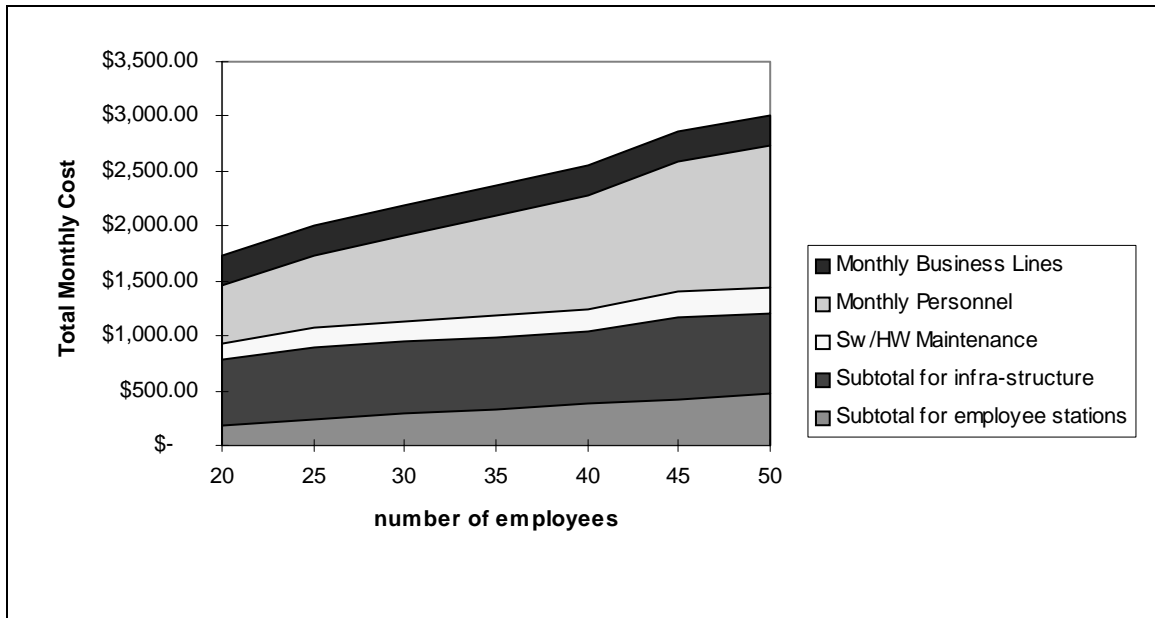
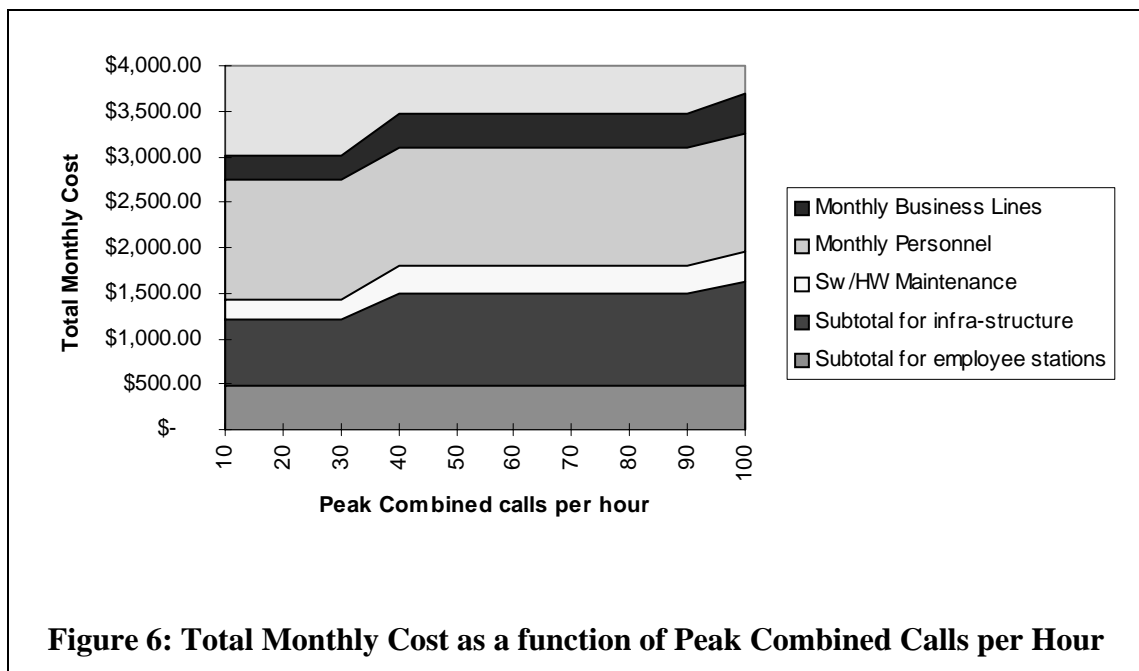
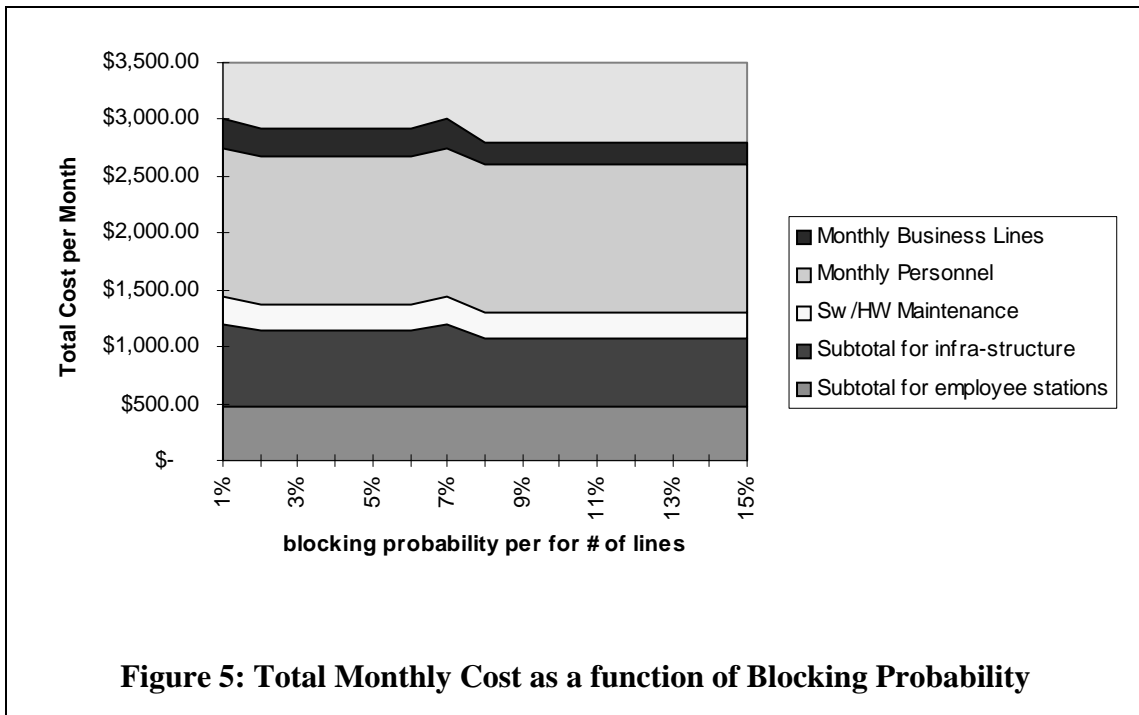

Figure 4: Total Monthly Cost as a Function of Number of Employees

Figure 4 shows a rising cost per month as the number of employees increases from twenty to fifty. However, this increase is not constant; it has some irregularities. These irregularities arise from the jumps that take place when major pieces of equipment must be added, such as additional Ethernet switches, to handle the additional employees added.

Figure 5 similarly shows jumps in the total monthly cost when the variable for the blocking probability for number of lines is varied. These jumps result from the reduction of the number of business lines as the blocking probability increases. The blocking probability is a value that expresses the likeliness that someone calling in to the network gets a busy signal. As the probability increases, the caller is more likely to get a busy signal. If the company accepts a higher number of callers receiving a busy signal, then it would need fewer telephone lines. The jumps in Figure 5 occur when the company needs one fewer line. The jumps are amplified by the loss of connecting equipment and software (i.e. for each business line, additional Internet telephony software and Dialogic boards will be needed).



Similar to Figure 5, Figure 6 shows jumps in the Total Monthly Cost when the number of Peak Combined Calls per Hour is varied. In this situation, however, the number

of lines and the accompanying equipment and software must be added to handle the addition voice traffic caused by an increase in the number of received calls.

In Figure 7, the Total Monthly Cost once again increases in jumps do to the lumpy nature of the costs associated with the use of additional phone lines. In this scenario, the additional lines are needed to handle the traffic caused by longer amount of time each line is in use.

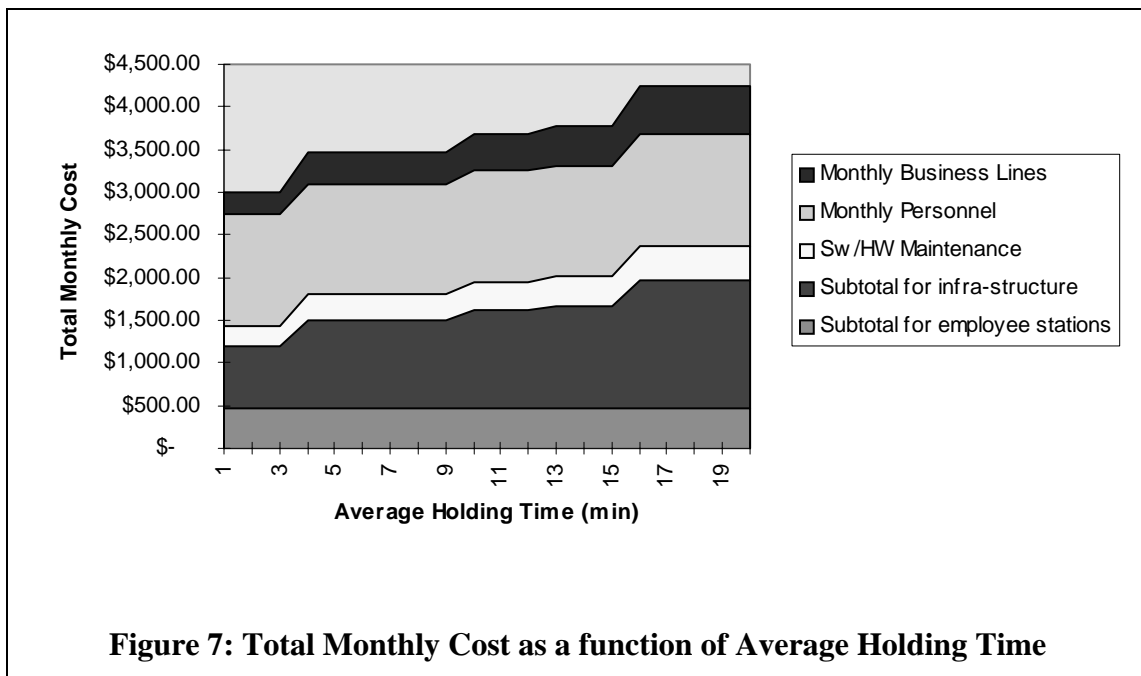

In Figure 8, the effects of an increase in the amount of support time per employee on the Total Monthly Cost is examined. As can be seen, the Personnel costs increase dramatically as more time per employee is needed to support Internet telephony applications. Internet telephony is an immature technology that could, especially during early stages of integration, demand significant amount of time by support personnel. If anything, this graph

suggests that the adoption of Internet telephony must be carefully studied before implementation in order to prevent skyrocketing personnel costs.

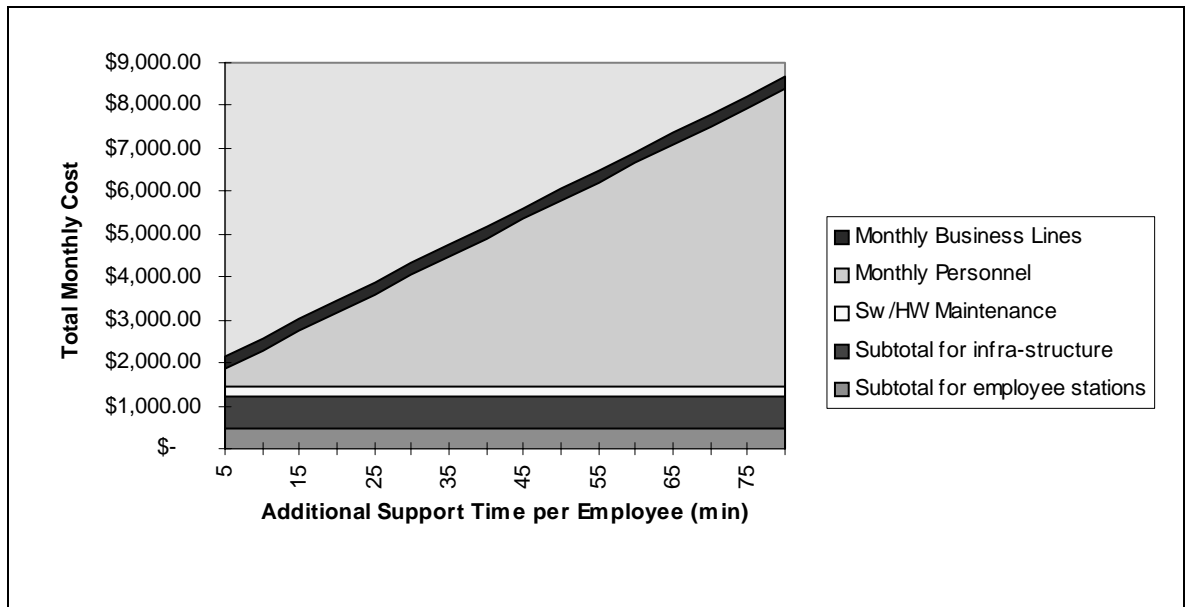

Figure 8: Total Monthly Cost as a function of Additional Support Time

Summary

This chapter has examined the output of the cost model, presented the results of the model when the default settings are entered for the input variables, and the sensitivity analysis of the input variables. It has shown that the Total Monthly Costs are often effected in jumps of cost due to the addition of expensive pieces of equipment or the addition of groups of equipment and software that must be added in tandem to achieve the desired results.

While the results presented focus on a scenario that can be implemented at this time, the costs for alternate scenarios are also dominated by the major cost categories of gateway costs and personnel costs. Over time, the software will be developed that will remove the need for Internet telephony software to be installed at every station. However, the need for

interconnection to the PSTN continue to force an increase in hardware and software investment that will drive the total cost of Internet telephony applications up until the cost of this product declines due to technological improvement or increased demand.

Chapter 4: Regulation and Internet telephony

With the explosion of the Internet into the daily lives of most Americans, it was only a matter of time before some question would arise to ignite the debate of whether the United States government should take on some role as a regulator of the Internet. In the last two years, the development of Internet telephony and its increased use have started such a debate. This debate not only questions the Federal government's role as a possible regulator in this arena, but it also points to the inefficiencies of the current telecommunications infrastructure and practices for voice communication. For businesses operating in many nations, Internet and telecommunications regulatory issues would need to be addressed in each country. A general statement on Internet telephony European policy developed in part by the author in the context of the ITC European Regulatory Task Force, is attached as Appendix E.

In this chapter, the history of Federal intervention in the telecommunications industry will be examined to gain a better understanding of the political context that prompted Federal regulation of communications, specifically voice communications, in the first place. This context will then be compared to today's political climate regarding telecommunications and the Federal government's role as its regulator. With this historical context at hand along with the technical understanding of Internet telephony, the statutes regarding telecommunications will be examined to determine whether the FCC could exercise its regulatory powers over this Internet service and whether it should, given the current political landscape.

Federal Regulation of Telephony--How It Came About and How it Changed

The telephone was invented in 1876 by Alexander Graham Bell during a time when the public had grown used to the concept of public service companies, that is, companies who

provide services to all the citizenry under reasonable conditions for reasonable compensation. In the area of communications, public service companies were already well-established in the form of telegraph companies; the dominant one being Western Union.

The telegraph had been invented during the 1830s. By the mid 1840s, the practical application of the telegraph had promised and delivered so much that it was rapidly being adopted by business as an important tool.⁴⁵ The telegraph changed the way that business was conducted and provided the means for expansion of the stock and money markets.⁴⁶ As the popularity and use of the telegraph grew, many telegraph companies sprung up during the 1840s. But throughout the 1850s, telegraph companies consolidated and ultimately Western Union turned out on top. This consolidation grew out of the need to invest large amounts of capital into the operation of telegraph companies as well as from the value of large networks to expedite delivery of messages and to insure that they would be delivered.⁴⁷ As reliance on the telegraph grew during the 1860s and 1870s, concern over its operation and availability began to arise. Senator John Sherman sought some kind of government intervention in this industry, but his attempts failed.⁴⁸ However, the importance of the telegraph as a “unique and critical contribution” to all communities was seen and noted by the Supreme Court in the case of *Pensacola Telegraph Co. v. Western Union Telegraph Co.* in 1877.⁴⁹ By the 1870s, some states felt so strongly about the value of telegraph service that they regulated telegraph companies.⁵⁰

⁴⁵ Alan Stone. *Public Service Liberalism: Telecommunications and Transitions in Public Policy*. Princeton University Press. Princeton, NJ: 1991. p.38.

⁴⁶ Stone. *Public*. p. 39.

⁴⁷ Stone. *Public*. p. 40-1.

⁴⁸ Stone. *Public* p. 42.

⁴⁹ Stone. *Public*. p. 42; 96 US 1 (1877).

⁵⁰ Stone. *Public*. p. 42.

Thus, when the telephone came along, the point of view of the time period was to see it in the same way as a telegraph, only anyone could use a telephone.⁵¹ The telephone was quickly adopted and the public service model of the telegraph was quickly applied to it.⁵² Regulation of telephone companies began early and was challenged in court just as quickly. But by 1892, the Supreme Court upheld state regulation of telephone companies.⁵³

The issue of Federal regulation of telephone companies arose in the early twentieth century. Like the telegraph industry, there was a move to consolidate telephone companies to take advantage of network benefits and interconnection. However, another issue also forced the consolidation of telephone companies and this issue was that of technological advancement--one of the earliest issues had to do with batteries.⁵⁴ Early telephones had local batteries that had to be cranked in order to send a strong enough signal that would still be heard after the attenuation that occurred as the signal traveled along the line. These hand crank batteries were difficult to use, so they were replaced by wet cell batteries. However, wet cells tended to corrode and damage equipment. The wet cells were eventually replaced by bulky dry cells. Eventually, the technology was created that enabled a common battery to be used at a central location, such as a central office.

However, the use of a common battery demanded some control over the end user equipment attached to it. To have such control, the company needed to invest significant capital and provide greater value to its customers through interconnection. The company that had the most to offer attracted the most customers. This gave leverage to the companies that could afford to make greater capital investments. The common battery and the technological

⁵¹ Stone. *Public*. p. 43.

⁵² Stone. *Public*. p. 38.

⁵³ *Budd v. New York* 143 US 517 (1892); Stone. *Public*. p. 45.

advances in switching and transmission equipment that followed led to a system where the natural outgrowth was a company that would have end-to-end control of the equipment.⁵⁵ In addition to the desire to own all the equipment, to attract the most customers, a company wanted to offer the most connections to other people. A larger company would clearly have the advantage over a smaller company. And to insure that everyone could communicate to everyone else, interconnection of all companies or having one company serve everyone was necessary. In order to best meet the needs of the public, the government agreed to allow a natural monopoly in the form of AT&T to be established in exchange for regulatory control.⁵⁶ This regulatory control was first under the Interstate Commerce Commission but eventually made its way into the Federal Communications Commission when it was established.

Yet, such an atmosphere of resignation to monopoly status of telephone based communications was not to be long enjoyed. Technological improvements to the system continued to be AT&T's way of maintaining control from end to end of its system. However, telecommunication needs were continuing to grow. Eventually, something had to give. This occurred when in the late 1960s⁵⁷ when the FCC allowed MCI to offer long-distance service via microwave transmission between Chicago and St. Louis. With this action, the security and control of AT&T had been breached. As the years went by and more and more companies wanted a piece of the prosperity of the long-distance voice market, a movement to deregulate sprang up. By the mid-1980s, the climate had changed to one where regulation was not seen as a benefit, but a hindrance to competition. In 1984, AT&T was ordered to

⁵⁴ Stone. *Public*. p. 80.

⁵⁵ Stone. *Public*. p. 80-1.

⁵⁶ Stone. *Public*. p. 184-5.

⁵⁷ Alan Stone. *Wrong Number: The Breakup of AT&T*. Basic Books, Inc.: New York. 1989. p. 20-1.

break up its monopoly and to get out of the local telephone market.⁵⁸ Though the telephone industry was still under Federal regulation after the break up of AT&T, the desire for change was growing still and more deregulation would eventually occur.

The trend towards deregulation of the telecommunications industry reached its next milestone in early 1996. The Telecommunications Act of 1996 was “the most sweeping overhaul of the nation’s telecommunications laws in more than 60 years.”⁵⁹ In this act, much of the legislation that was already in place was re-written to reflect the changes that had taken place in the technology of telecommunications. Besides addressing technological advancement, the 1996 Act sought to replace regulatory mechanism with marketplace mechanisms. The local telephone loop was opened up for competitive practices for any company that wished to provide end-user service. Such a regulatory change opened the door for long-distance carriers to provide end-to-end service, but also provided the same end-to-end potential to regional carriers and to other non-traditional voice providers as cable operators.

Implementation of the 1996 Act has been slowed by legal challenges with many complaining that the FCC does not have jurisdiction to force competition in the local telecommunication markets.⁶⁰ While the FCC tries to bring this case before the Supreme Court, telephone companies increasingly seek delay in order to retain their current markets.⁶¹ In this light, Internet telephony has been pointed to as being even more important because of its potential to further open the local, long-distance, and international telecommunication

⁵⁸ Stone. *Wrong*. p. 314.

⁵⁹ Kirk Victor. “Media Monsters.” *National Journal*. v28 n9. p. 480.

⁶⁰ Hundt, Reed E. “The Internet: From Here to Ubiquity.” speech. 26 August 1997.

⁶¹ Hundt, Reed E. “The Internet: From Here to Ubiquity.” speech. 26 August 1997.

markets. The development of Internet telephony software and its use for long-distance, as well as local telephone calls, will enable users of Internet telephony to have alternate means of access to telecommunications services. Internet telephony's development may also yield another method for long-distance carriers to transmit voice signals if a carrier were to choose to provide long-distance services using Internet telephony software.

The FCC, the Internet, and Access Charges

As the Internet and the political attitude of deregulation have grown, the idea of increased regulation, or at least increased application of existing regulation, has come up in relation to the Internet. Specifically, in March 1996, a petition was filed with the FCC requesting special relief from “unauthorized provisioning of telecommunication services” through the sale and use of Internet telephony software.⁶² The America's Carriers Telecommunication Association (ACTA), a trade group of independent long-distance carriers, filed the petition to force the FCC to exercise its authority over interstate and international telecommunications services.⁶³ ACTA perceived a threat from the ability of Internet telephone software to be used to by-pass access charges and other forms of Federal and State regulation of telecommunication services that are implemented to support and promote the cause of universal service.⁶⁴ ACTA also argued that this capability put them at an economic disadvantage because up to forty percent of the cost of a regular long-distance phone call was access charges.⁶⁵ The FCC considered this matter and requested comments on the petition. In the end, the FCC took no action because the regulation of software was

⁶² ACTA Internet Phone Petition [RM No. 8775].

[http://www.fcc.gov/Bureaus/Common_Carrier/Other/actapet.html].

⁶³ ACTA press release. “FCC petitioned to stop misuse of the Internet!” 4 Mar. 1996.

[<http://www.pulver.com/von/vonyes/actapet.htm>].

⁶⁴ ACTA petition.

perceived as outside of its statutory mandate as well as the belief that the technology was still in a developmental stage; in a speech given by FCC Chairman Reed Hundt, he expressed the attitude that the first response to regulating new technology shouldn't be automatically applying old regulation.⁶⁶

However, the concern over access charge bypass may not be as great a concern in future Internet telephony related issues that come before the FCC. In the Telecommunications Act of 1996,⁶⁷ one of the changes that Congress required the FCC make was how access charges were used to implement universal service. The statute requires that the universal support mechanisms, namely access charges, be non-discriminatory and equitable; that is, that the support mechanisms not be solely funded by the long-distance carriers but be funded by all suppliers of interstate telecommunications service.⁶⁸ With the opening of all telecommunications markets due to the 1996 Act,⁶⁹ this will spread the cost of universal service to all entities that want to participate in interstate service provisioning, thus expanding the pool of potential contributors to universal service and hopefully lessening the burden any subset of contributors must bear. So, in theory, the cost of a regular long-distance call would no longer be made up of up to forty percent access charges to support universal service. In the future, companies opposed to the increase of use of Internet telephony may still complain that Internet telephony is only used to bypass access charges, but this argument

⁶⁵ Bart Ziegler. "Telecommunications (a special report): making the call." *WSJ*. 16 Sept. 1996. Sec. R. p. 13.

⁶⁶ Reed Hundt. Speech before INET '96 Conference. 28 June 1996.

[<http://www.fcc.gov/Speeches/Hundt/spreh629.txt>].

⁶⁷ The Telecommunications Act of 1996 amends the Communications Act of 1934, 47 USC §§151 *et seq.*

⁶⁸ *Report & Order In the Matter of Federal State-Joint Board on Universal Service*. FCC 97-157, CC Docket No. 96-45. p. 7.

⁶⁹ 47 USC § 253.

will have less of an impact since the companies could no longer claim an economic disadvantage.

As a companion to the universal service report, the Common Carrier Bureau of the FCC announced that access charge reform is underway.⁷⁰ In order to preserve universal service, predictable and sufficient mechanisms will be adopted to fund universal service per the 1996 Act.⁷¹ These mechanisms will be adopted through changes in the rate structure that will clearly show from whom the support is coming and what amount of the support they will bear.⁷² The FCC hopes that this change in rate structure will promote the development of information services in the United States and thus benefit the American people.⁷³ With a clearer and equitable rate structure for access charges the arguments that Internet telephony has a competitive advantage because it is not subject to regulatory oversight will be lessened. And if a provider of Internet telephony does become subject to regulatory oversight and must pay access charges to support universal service, the clearer rate structure will enable potential users to focus on the technological differences that enable Internet telephony to be offered for a lower rate, rather than wonder if the savings stem from lack of access charges.

The FCC has faced the changing circumstances surrounding telecommunications by trying to understand the technology as well as the political climate it finds itself in. When examining the service of Internet telephony, the FCC finds itself with an issue of ever growing importance. Though the FCC chose not to act where the ACTA petition was concerned, that does not mean that Internet telephony is out of its purview. As the

⁷⁰ Common Carrier Bureau news release. "Commission reforms interstate access charge." CC Docket No. 94-1. 7 May 1997. [http://www.fcc.gov/Bureaus/Common_Carrier/News_Releases/1997/nrcc7034.htm].

⁷¹ 47 USC § 254(d)-(e).

⁷² Common Carrier news release. 7 May 1997.

⁷³ Common Carrier news release. 7 May 1997.

technology changes, it becomes increasingly possible for a business to start up that sees itself as a provider of interstate telecommunications services using an infrastructure based on the Internet and Internet telephony rather than the PSTN. With this in mind, the statutes governing the FCC and its regulation of interstate telecommunications services must be examined specifically within the framework of Internet telephony.

US Statutory Law and Internet Telephony

Whenever any aspect of regulation and the Internet is considered, one thing must be kept in mind. The Federal government has gone to great lengths to keep from regulating the Internet. The Telecommunications Act of 1996 even states that one of its guiding principles is “to preserve the vibrant and competitive free market that presently exists for the Internet and other interactive computer services, unfettered by Federal or State regulation.”⁷⁴

However, no where does the Federal government give up the right to regulate the Internet; in fact, through the Communications Decency Act (CDA), Congress has expressly tried to regulate the Internet to prevent children from being exposed to indecent material.⁷⁵ In most cases, the government has tried to maximize the public benefit from the Internet by allowing it to remain in a competitive state.

While the Federal government may not attempt to regulate the Internet per se, does it have to take the same point of view where Internet services are concerned? Since Internet services can be the functional equivalent of other telecommunications services--that is telephony can be provided over the PSTN or over the Internet; video programming can be

⁷⁴ 47 USC § 230 (b).

⁷⁵ 47 USC § 223. The ACLU filed a lawsuit to overturn the CDA shortly after it was signed into law. This suit eventually ended up before the Supreme Court and the CDA was found unconstitutional. More information on this suit and others filed to overturn the CDA can be found at: [<http://www.cpsr.org/cpsr/nii/cyber-rights/web/cda/lawsuits.html>].

provided over broadcast, cable or the Internet--the analogy can be made that Internet service providers who provide functional equivalent services to telecommunications service providers can be regulated as interstate telecommunication service providers. This argument can be furthered by the fact that Internet services rely on communications infrastructure that is already under FCC regulation.⁷⁶ From this point of view, Internet services can fall under FCC regulation.

Internet services often seem to fall into the category of an “enhanced service.” The definition of enhanced services came into being during the 1970s when services such as protocol processing and alarm monitoring began being used over the interstate transmission facilities of AT&T. An enhanced service is “. . . a service that is offered over common carrier transmission facilities. . . which employ computer processing applications that act on the format, content, code, protocol, or similar aspects of the subscriber’s transmitted information. . . .”⁷⁷ On the other hand, basic services include standard voice transmission. While Internet telephony does use computer processing to act on the user’s transmitted information, the FCC has held that the utilization of packet-switching for processing and transmitting voice communication (which is the basis of Internet telephony) does not make it an enhanced service in all instances.⁷⁸ Thus, when Internet telephony is being used as a means of transport transparent to the user, it is not an enhanced service whereas actual utilization of the Internet directly by the consumer (such as purchasing Internet telephony software and using it to call others using that software) could be seen as an enhanced service.

⁷⁶ Kevin Werbach. *Digital Tornado: The Internet and Telecommunications Policy*. OPP Working Paper No. 29. March 1997. Sec. III (A). [http://www.fcc.gov/Bureaus/OPP/working_papers/oppwp29.pdf] Note: References to this article refer to section and sub-sections; pagination of documents off the web may not coincide with the printed version.

⁷⁷ Werbach. Sec. III (B) (b).

The question of the jurisdiction of the FCC is not explicitly addressed anywhere in the Telecommunications Act of 1996; no limitations on FCC jurisdiction are set in any form.⁷⁹ However, the Communications Act of 1934 does give the FCC the authority to “regulate interstate and foreign commerce in communication by wire and radio.”⁸⁰ The question that arises is whether Internet telephony is a form of interstate commerce in communication. Telecommunications is defined as the transmission between points, as specified by the user, of the user’s chosen information via the user’s chosen method.⁸¹ A telecommunications service is offering telecommunications at a fee to the public regardless of the facilities used.⁸² The technology of Internet telephony is rapidly approaching the point where whether it is used to provide the basic communications service or not is transparent to the user. At such a stage, it could be offered for a fee as an alternative to current long-distance providers. In such a case, Internet telephony enables communication between two points utilizing a media of the sender’s choice; it does provide commerce in communication. So Internet telephony does satisfy this aspect of whether the FCC could regulate it.

Another consideration is whether the use of Internet telephony can create a significant competitive impact. The FCC has repeatedly used the potential competitive impact of a new technology as a entry for regulation. The potential competitive threat of cable to broadcast television was and is a major reason for the continued regulation of the cable industry by the FCC.⁸³ So, could Internet telephony be considered a competitive threat to the telecommunications industry? This is a debatable question. As it stands today, Internet

⁷⁸ Werbach. Sec. III (B) (b).

⁷⁹ Werbach. Sec. III (A).

⁸⁰ 47 USC § 151.

⁸¹ 47 USC § 153 (43).

⁸² 47 USC § 153 (46).

telephony is not a threat. It cannot provide a comparable quality of service and cannot provide comparable services (such as call waiting) that today's telecommunications service providers offer. While some price-sensitive consumers may opt to use today's Internet telephony software packages, they do not comprise a large enough economic force to cause the interstate telecommunications industry to crumble.

European Regulation and Internet Telephony

The status of Internet telephony in the European Union is similar to that of the US. The EU is beginning to take serious notice of Internet telephony as can be seen by its Notice Concerning the Status of Voice on the Internet under Directive 90/388/EEC.⁸⁴ In this Notice, the Directorate-General for Competition (DGIV) proposed an approach to the growing use of Internet telephony in Europe. They proposed a set of criteria that Internet telephony must meet if it is to be classed as voice telephony and thus be subject to current regulations. These criteria are listed below.

Such communications are subject of a commercial offer.
Such communications are provided for the public.
Such communications are to and from the public switched network termination points on a fixed telephony network.
Such communications involve direct transport and switching of speech in real-time.

Table 11: EU Criteria for Voice Telephony⁸⁵

By the EU's criteria, Internet telephony cannot be considered voice telephony because delays in the processing and transmission of the voice signal over the public Internet result in non-real-time transmission.⁸⁶ Since Internet telephony does not meet these criteria, it is not

⁸³ Werbach. Sec. III (A); *US v. Southwestern Cable Co.* 392 US 157 (1968).

⁸⁴ OJ C 140, 7.05.1997, p.8

⁸⁵ Source: Notice Concerning the Status of Voice on the Internet under Directive 90/388/EEC

⁸⁶ ITC European Regulatory Task Force, p. 2

classed as voice telephony and thus falls into the liberalized area so that providers of Internet telephony do not fall under the same regulations as voice telephony providers.

At this writing, the response to this Notice has been favorable with most respondents supporting the “no regulation at this time” approach. In general, most feel that the Internet should be free of regulation and that Internet telephony needs time to mature.⁸⁷

Conclusion

Does Internet telephony offer a potential threat? In today’s atmosphere of changing regulation for telecommunications service providers, Internet telephony probably is not a threat. The restructuring of access charges will create a more equitable distribution of the costs and profits associated with long-distance telephony that will not be significantly disturbed through the offering of Internet telephony. This restructuring will enable new technologies (like Internet telephony) to be utilized for interstate telecommunications services. With a more competitive atmosphere in the provisioning of communication services, the possibility that Internet telephony could become a significant player does present itself. Internet telephony technical advantages in its resource utilization could be a competitive advantage that may overcome its initial lack of wide deployment.

Much of this statutory consideration seems to hinge on whether Internet telephony is being consciously used by the consumer or whether it is transparent to the consumer and at what scale it is being used. When Internet telephony is consciously chosen by a consumer to run on his computer, Internet telephony seems to fall outside of reach of the FCC. As it currently exists, such a consumer would have few people to contact via this technique relative to the millions accessible through the PSTN. In this case, the FCC does not regulate

primarily because at such a limited scale, it would not be in the public interest to regulate it. There would be no benefit to the public to do so and such regulation may stifle the innovation of the technology.

If and when Internet telephony is used by a company specifically to provide interstate telecommunications services to its customers, then the FCC would be able to regulate it, if the public would benefit from such regulation. In this case, the motives of the company are no different from other inter-exchange carriers. Such a company would have to have some way to interconnect to the PSTN; otherwise, the business would have limited value. Since the Congress still feels that universal service is a worthy cause, such regulation would take place and the company should be treated as any other provider of interstate telecommunications services.

How Internet telephony will continue to evolve is unknown. It has the potential to dramatically change the way communications are handled in not only the United States, but in the rest of the world as well. With such potential, the Federal government would be unwise to ignore such a technology. Ultimately, the choice must be made on what will benefit the public the most. In today's political climate, that choice will be very different from the one when telephony was first regulated. The United States is no longer a country that sees regulation as the final answer; more often than not, the competitive market is seen as the solution. Whether that is the correct choice is difficult to determine even under the best circumstances.

⁸⁷ The Notice and Comments submitted to DGIV in response to the Notice can be found at [<http://www.europa.eu.int/en/comm/dg04/lawliber/libera.htm>].

Chapter 5: Conclusions

This chapter summarizes the results of the thesis that examined the costs of the addition of Internet telephony to a company's LAN to replace a traditional voice telephony network. The costs of using Internet telephony are discussed in greater detail, as are the advantages and disadvantages of such a system. Areas of concern, including the impact of potential regulatory barriers are also discussed. The chapter concludes with recommendations for further research.

The Costs of Internet telephony

The results for the base scenario are repeated in Table 12, Figure 9, and Figure 10 and followed by discussion of key points each table or figure makes. These results represent the costs associated with adding Internet telephony to a LAN that serves 50 employees.

Subtotal for Employee Stations	\$472.60
Subtotal for Infrastructure	\$725.31
Annualized Equipment Cost	\$1197.92
SW/HW Maintenance	\$239.58
Personnel	\$1302.08
Business Lines	\$272.00
Monthly Operations Cost	\$1813.67
Total Monthly Cost	\$3011.58
Cost / Employee / Month	\$60.23

Table 12: Results for Base Scenario

Table 12 shows that the costs for adding Internet telephony to the network is considerable. At \$60.23 per employee per month, the cost of enabling that employee to use Internet telephony is nearly twice what it would cost to give that employee their own private business line (assuming the business line cost approximately \$34 per month). The use of fifty business lines instead of Internet telephony as described in this thesis would result in over \$1300 savings per month. Strictly from a cost perspective, there is not an incentive to

convert from using a telephone system and a data system to one integrated voice/data system at this time.

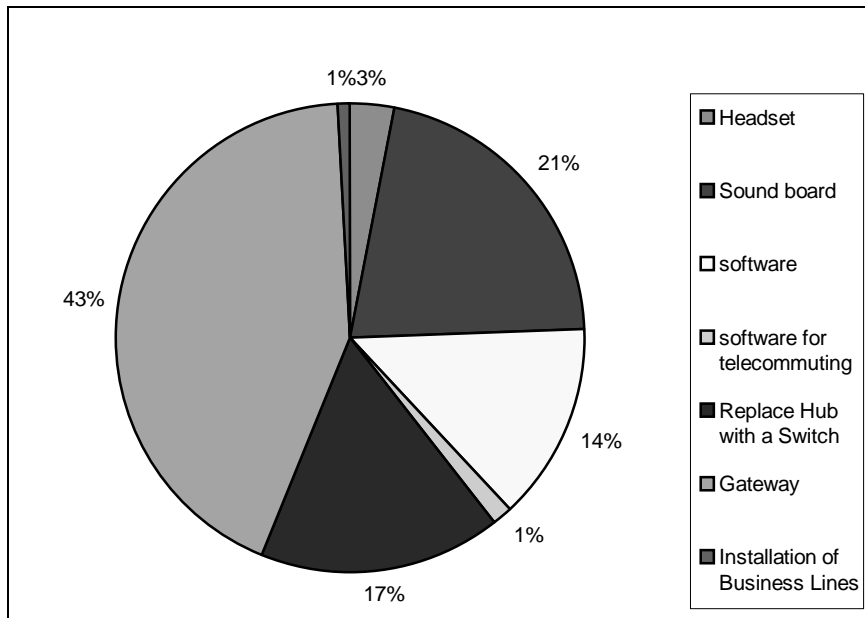
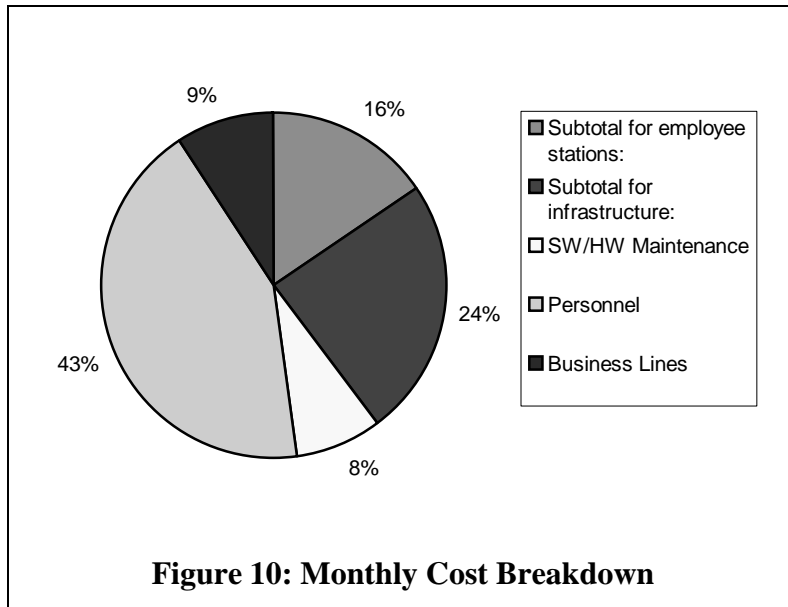

Figure 9: Equipment Breakdown

A closer examination of the equipment cost reveals from where a large amount of the monthly costs stem. Figure 9 shows a breakdown of the equipment costs for the base scenario. From this diagram, it can be seen that the bulk of the costs arise from the gateway server needed to interconnect with the PSTN. The gateway costs are driven up by the cost for the software needed for each incoming line. Few companies offer gateway equipment; because of this, the price is high due to lack of demand and the lack of a truly competitive market. The high price for the software needed for each incoming line drives up the total equipment costs while providing little more functionality than a PBX and a facsimile machine would offer.



The monthly cost breakdown, as shown in Figure 10, is overwhelmed by the personnel cost. The personnel cost is highly subjective because such a system as proposed in this thesis has yet to be put together. It is uncertain what kind of operational support will be needed. As such, erring on the side of caution seemed more favorable than erring on the side of optimism; thus, twelve and a half hours of operations support per week was included in the final cost. With the maturation of Internet telephony technology, such a system would likely need less support and the personnel cost is likely to decrease over the economic life of the system. System upgrades would however result in short-term increases in personnel costs as more personnel is needed to handle the bugs and mishaps that often occur when software and hardware are added to a computer network.

In the future, assuming the Internet telephony technology continues to improve and be in greater demand, the decrease of both these significant cost areas could result in a cost per month per employee comparable to that of providing each employee with their own phone

line.⁸⁸ The decrease in the cost per line could occur as demand for the product increases while the personnel costs would lower as the technology matures. However, providing a voice line for every employee is often beyond the financial means of most small companies.

Concerns for the use of Internet telephony

A network that is running Internet telephony must be carefully planned. Not only must it be able to provide voice services on demand, but it must also be able to provide sufficient resources to handle the computing needs of the users. While the network may be sized appropriately to handle these needs (for this model, the use of switched Ethernet to the desktop lessened the effect of bandwidth congestion on the sizing of the network), the network still must run in a timely manner. However, networks are not known for their reliability. Servers go down often and when that occurs, unless there are sufficient backups in place to handle demand, the applications available on those servers are not available until the server is back on line. This model did not examine what would be necessary to back-up an Internet telephony system. With the addition of any new piece of software, the likelihood of a system failure increases—added complexity results in added potential problems. The complexity of integrating voice and data systems must be carefully considered before any systems administrator would add Internet telephony to their LAN in the manner proposed in this thesis.

⁸⁸ The model was run with the cost for Internet telephony software for each phone line set to \$500 and the cost for each fax line set to \$370. With these values, the cost per month dropped to \$55.31, given the level of support at 15 minutes per employee per week. At a level of personnel support of only 5 minutes per employee per week, the cost per employee per month drops to \$37.95. The value of \$500 per line was taken from a comment made during a conference call between the author and ITC Member Companies on May 21, 1997 when the comment was made that gateways would not take off until the cost per line was less than \$500. The value for the fax line was set proportionally.

However, the additional functionality that could be provided by Internet telephony cannot be easily dismissed. Internet telephony provides a means of real-time communication that does not require the users to be excellent typists. Vocal communication was present long before the written word and will probably outlast the Internet, in its current form. Internet telephony provides a means of having voice communication over a computer network. Not only that, but more advanced forms of Internet telephony, which includes variations on whiteboarding for collaborative work, could create a business communication environment where employees are interacting and sharing information in a manner that supports company productivity. Yet, it cannot be determined what effect Internet telephony will have on the future of business communication—the technology is too immature and not widespread enough to see how businesses would use it on a daily basis.

An increase in the use of Internet telephony will either be helped or hindered by the increased interest of regulatory agencies in this technology.⁸⁹ The suggestion by some groups (such as ACTA) to regulate Internet telephony at this time would only hinder its development. The technology is new and it must be allowed to develop, much like the telephone industry in its infancy. During the years immediately after its invention, telephone companies were not subject to any regulation. It was only as the market for telephone usage expanded and the benefits of a unified network were seen that regulatory oversight was pursued. A similar situation may arise for Internet telephony, but in its current state, the possibility for regulation seems a distant prospect.

⁸⁹ For example, the National Telecommunications and Information Administration of the Department of Commerce is holding a day-long forum on Internet Telephony on September 4, 1997 to discuss the implications of this technology. More information can be found at [<http://www.ntia.doc.gov/forums/telephony/intelhome.htm>].

This potential for regulation of Internet telephony and its equipment will likely slow its adoption by the business community. In business, sometimes risks are taken and sometimes they are not. With communication, more likely than not, risks are not taken. The risk of installing equipment that may one day cost more to operate than it currently does due to access charges, is not a risk most businesses, small or large, are willing to make. One day, the technology may cost less to operate, at that time, the risk may be worth it. But at the costs found in this thesis, that day has not yet arrived. Regulatory barriers if implemented in the near future will only frustrate the development of the technology. Regulatory barriers implemented after the costs of the technology have declined will only stifle its adoption, even if there is a clear technological advantage for the use of the technology.

Future areas of research

Many areas of research exist in this topic. The model could be extended to model the cost of the entire network so that different variations of network configuration could be considered.⁹⁰ The subject of how Internet telephony would change business communication is another area where more research needs to be performed. How would employees adapt to using the computer as their only source of communication in the office (as the computer assumes the tasks previously performed by the telephone and the fax machine)? The effect of multiple Internet telephony conversations on the switches and servers also needs to be established since, depending on the software, more lines of communication between multiple people could be set up for an indefinite amount of time (much different from the Poisson distribution found for traditional telephone calls).

⁹⁰ For example, instead of having a separate gateway server, the pieces necessary could be added to an existing server, the effect of the Internet telephony software on that server and its demand relative to the other applications offered off of that server would pose an interesting question to consider.

A final area where more research needs to be done, is the examination of how different types of Internet telephony affect the network. For this model, Internet telephony was taken as a low-level form of teleconferencing with some additional features. However, many of the advantages of having Internet telephony in place stem from the applications that utilize Internet telephony's more advanced features such as video conferencing and real-time document sharing and collaboration. These functions would have a different bandwidth profile and thus create a different load on the network. How the use of these kinds of applications would affect network architecture needs to be examined.

In summary, Internet telephony is a technology that, in its current state, will be expensive to implement on a wide-spread basis in a business environment. Future development of the technology may result in a lower cost, but the costs associated with keeping the network running in a reliable state, as seen through increased operations personnel costs, must also decline if this technology is to be adopted. Also, the increased interest by regulatory agencies in Internet telephony leave its future development in question as these agencies decide whether they need to regulate this technology or how they might do so if needed.

Bibliography

- “Busy, Busy.” *Newsweek*. 31 March 1997: 10.
- ACTA Internet Phone Petition [RM No. 8775].
- ACTA press release. “FCC petitioned to stop misuse of the Internet!” 4 Mar. 1996.
- Brealy, Richard A. and Stewart C. Myers. *Principles of Corporate Finance*. McGraw Hill: New York. 1996.
- Breyer, Robert, and Sean Riley. *Switched and fast ethernet: how it works and how to use it*. Emeryville, CA: Ziff-Davis Press. 1995.
- Clark, David. “A taxonomy of Internet Telephony Applications.” Draft ITC document.
- Common Carrier Bureau news release. “Commission reforms interstate access charge.” CC Docket No. 94-1. 7 May 1997.
- Duffy, Jim. “Eli Lilly cures IP ills.” *Network World*. 25 Nov. 1996.
- Gibbs, Mark. “The Intranet Scale Problem.” *Datamation* Dec. 1996: 38.
- Griffiths, J. M., ed. *Local Communications 2: into the digital era*. London: Peter Peregrinus Ltd., 1988.
- Hale, Constance. ed. *Wired Style: Principles of English Usage in the Digital Age*. HardWired: San Francisco, CA. 1996.
- Hills, Melanie. *Intranet business strategies*. New York: John Wiley & Sons, 1997.
- Hundt, Reed E. “The Internet: From Here to Ubiquity.” speech. 26 August 1997.
- Hundt, Reed E. Speech before INET '96 Conference. 28 June 1996.
- ITC European Regulatory Task Force. “Comment to the European Commission Concerning the Status of Voice on the Internet under Directive 90/388/EEC.” July 1997.
- Kaplan, Jeffery. “Getting intranet-ready is harder than it seems.” *Network World*. 2 Dec. 1996.
- Lambert, David R. “Perfect networks: hub & adapter.” *PC Magazine*. July 1997. p. 159.
- Leida, Brett. “A Cost Model of Internet Service Providers: Implications for Internet Telephony and Yield Management.” thesis. MIT, 1997.
- Merril Lynch. *Security Risk Evaluation*.(Beta Book). July 1997.
- Morro, David. “Ask Dr. Intranet.” *Intranets*. Feb. 1997.
- Pindyck, Robert S. “Lecture Notes on Production, Cost, and Demand.” reading packet. July 1995.
- Rush, William, and Michael Josephs. “Crank it up.” *Intranets*. Feb. 1997: 26-7.
- Sears, Andrew, Phil Mutooni, Rob Cheng and others. “A Cost Model of Internet Telephony for Regulatory Decision Making.” FCC Comment. 7 May 1996.
- Stone, Alan. *Wrong Number: The Breakup of AT&T*. Basic Books, Inc.: New York. 1989.
- Stone, Alan. *Public Service Liberalism: Telecommunications and Transitions in Public Policy*. Princeton University Press. Princeton, NJ: 1991.
- US Dept. of Commerce, County Business Patterns, United States, government publication CPB-94-1, Table 1b.
- Victor, Kirk. “Media Monsters.” *National Journal*. v28 n9. p. 480.
- Werbach, Kevin. *Digital Tornado: The Internet and Telecommunications Policy*. OPP Working Paper No. 29. March 1997.
- Wired Style: Principles of English Usage in the Digital Age*

Ziegler, Bart. "Telecommunications (a special report): making the call." *WSJ*. 16 Sept. 1996. Sec. R. p. 13.

Legal References

47 USC § 151.

47 USC § 153 (43).

47 USC § 153 (46).

47 USC § 223.

47 USC § 230 (b).

47 USC § 253.

47 USC § 254(d)-(e).

Budd v. New York 143 US 517 (1892).

Official Journal. OJ C 140, 7.05.1997.

Pensacola Telegraph Co. v. Western Union Telegraph Co. 96 US 1 (1877).

Report & Order In the Matter of Federal State-Joint Board on Universal Service. FCC 97-157, CC Docket No. 96-45. p. 7.

Telecommunications Act of 1996 amends the Communications Act of 1934, 47 USC §§151 *et seq.*

US v. Southwestern Cable Co. 392 US 157 (1968).

Web Sites

"Audiotrix Phone" [<http://www.mediatrix.com/atphone.htm>].

"County Business Patterns for the United States for the year 1994"
[<http://www.census.gov/prod/2/bus/cbp94/cbp94-1.pdf>].

"Internet Telephony Consortium" [<http://itel.mit.edu>].

"Netspeak" [<http://www.netspeak.com/>].

"The Amazing Fishcam" [<http://www2.netscape.com/fishcam/fishcam.html>].

"VocalTec Internet Phone" [<http://www.vocaltec.com/iphone4/ip4.htm>].

ACTA Internet Phone Petition [RM No. 8775].

[http://www.fcc.gov/Bureaus/Common_Carrier/Other/actapet.html].

ACTA press release. "FCC petitioned to stop misuse of the Internet!" 4 Mar. 1996.

[<http://www.pulver.com/von/vonyes/actapet.htm>].

Available Internet telephony software packages list [<http://itel.mit.edu/software.html>].

Common Carrier Bureau news release. "Commission reforms interstate access charge." CC Docket No. 94-1. 7 May 1997.

[http://www.fcc.gov/Bureaus/Common_Carrier/News_Releases/1997/nrcc7034.htm].

Kevin Werbach. Digital Tornado: The Internet and Telecommunications Policy. OPP Working Paper No. 29. March 1997. Sec. III (A).

[http://www.fcc.gov/Bureaus/OPP/working_papers/oppwp29.pdf]

National Telecommunications and Information Administration day-long forum on Internet Telephony [<http://www.ntia.doc.gov/forums/telephony/intelhome.htm>].

NITA event Thurs?

Reed Hundt. Speech before INET '96 Conference. 28 June 1996.

[<http://www.fcc.gov/Speeches/Hundt/spreh629.txt>].

Suits to overturn the CDA [<http://www.cpsr.org/cpsr/nii/cyber-rights/web/cda/lawsuits.html>].

System requirements for VocalTec's Telephony Gateway

[http://www.vocaltec.com/products/gtw/gtw_requirements.htm].

The Notice and Comments submitted to DGIV in response to the Notice can be found at

[<http://www.europa.eu.int/en/comm/dg04/lawliber/libera.htm>].

Tolly, Kevin. "Comparing LAN switch contenders: beyond performance"

[<http://www.xylan.com/STUDIES/NETWORLD/960701.HTM>].

Appendix A: Acronyms

ACTA - America's Carriers Telecommunications Association. Group of all smaller Inter-Exchange Carriers (Ma & Pop long distance companies etc.).

API - Application Programmer Interface - High level programming language specific to the Internet. i.e. Winsock.

ITAPI - Internet Telephony Application Programmer Interface.

ITVAPI - Internet Television Application Programmer Interface

ATM - Asynchronous Transfer Mode - Packet switching network.

CO - Central Office.

ESP - Enhanced Service Provider.

FCC - Federal Communication Commission.

FTP - File Transfer Protocol.

IAP - Internet Access Provider.

IDT - International Discount Communications.

IP - Internet Protocol - Address.

IPOP - Internet Point of Presence.

ISP - Internet Service Provider - Includes: UUNET, PSINET, MCI, Sprint.

IT - Internet Telephony.

IXC - Inter-Exchange Carriers - Includes both the big long distance carriers (AT&T, MCI, Sprint) and the smaller companies in the ACTA.

LD - Long Distance. - Usually referring to long distance carriers (Big ones: AT&T, MCI, and Sprint).

LEC - Local Exchange Carrier.

NAP - Network Access Point - Any one of five main connections forming the internet backbone.

NRC - Non-Reoccurring Charge.

ODN - Open Data Network.

OPP - Optional Payment Plan.

PBX - Private Branch Exchange - Internet phone network.

PCS - Personal Communication Service - Specific to mobile communications. i.e. mobile phones, pagers, Newton.

POP - Point of Presence - Generic term for telecommunication hardware.

POTS - Plain Old Telephone Service.

QoS - Quality of Service.

RBOC - Regional Bell Operating Companies - The seven regional carriers formed after the regulated break-up of AT&T.

RSVP - Reservation Protocol.

TCP - Transmission Control Protocol.

UDP - User Datagram Protocol - Bare minimum transfer protocol; no flow control, etc.

Appendix B: Cost Model Input Table

The following is a copy of the Input Table from the cost model. The values shown are for the base scenario.

USER INPUTS				
This worksheet shows all user-modifiable inputs. Values in italics are computed; do not change these.				
You may change values in blue and then set the "use default" option to "N" to see the effect of the change on the outputs.				
Adding Internet Telephony to LAN				
Input Name	Default (from mod)	Manual (from user)	Use Default (Y or N)	Input
Employee Information				
number of employees (20 to 50)	50	50	Y	50
percent of employees who telecommute	10%	10%	Y	10%
number of employees capable of telecommuting	5	5	Y	5
Capital Equipment				
Discount factor (received from vendors)	20%	20%	Y	20%
Business Line Information				
Voice				
blocking prob for # lines	1%	1%	Y	1%
peak combined calls per hour	20	20	Y	20
avg holding time(min)	2	2	Y	2
number of business lines	4	4	Y	4
Fax				
blocking prob for # lines	1%	1%	Y	1%
peak combined calls per hour	3	3	Y	3
avg holding time(min)	1	1	Y	1
number of fax lines	4	4	Y	4
number of voice + fax lines				8
cost for installation per business line	\$50	\$50	Y	\$50
cost per month for business line	\$34	\$34	Y	\$34
End User Equipment				
Receive discount from vendor? (Y or N)	Y	Y	Y	Y
lightweight headset with boom microphone	\$25	\$25	Y	\$25
economic life (months)	36	36	Y	36
sound board	\$200	\$200	Y	\$200
economic life (months)	36	36	Y	36
Audiotrix Phone	\$495	\$495	Y	\$495
economic life (months)	36	36	Y	36
Network Changes				
Receive discount from vendor?	Y	Y	Y	Y

Desktop Ethernet Switch	\$3,995	\$3,995	Y	\$3,995
economic life (months)	36	36	Y	36
number of ports	22	22	Y	22
number of Switches needed				3
Workgroup 10Base -T Hub	\$1,000	\$1,000	Y	\$1,000
economic life (months)	36	36	Y	36
number of ports	24	24	Y	24
number of Hubs to replace				3
Internet Telephony Software/Hardware				
Itel software packages	\$50	\$50	Y	\$50
Receive discount from vendor?	Y	Y	Y	Y
economic life (months)	18	18	Y	18
Itel license for X clients	\$3,000	\$3,000	Y	\$3,000
Receive discount from vendor?	Y	Y	Y	Y
economic life (months)	18	18	Y	18
number of clients	50	50	Y	50
number of licenses	1	1	Y	1
Itel Gateway Server				
Receive discount from vendor?	N	N	Y	N
economic life (months)	36	36	Y	36
number of voice lines	4	36	Y	4
Internet telephony software cost per voice line	\$1,350	\$1,000	Y	\$1,350
number of fax lines	4	4	Y	4
Internet telephony software cost per fax line	\$995	\$1,000	Y	\$995
number of Dialogic Boards	2	2	Y	2
cost per Dialogic board	\$600	\$600	Y	\$600
number of fax modems	4	4	Y	4
cost per fax modem	\$150	\$150	Y	\$150
server	\$3,000	\$3,000	Y	\$3,000
number of servers	1	1	Y	1
Installation costs				
cost per hour to install	\$25	\$25	Y	\$25
time to install headset per PC (hours)	0.25	0.25	Y	0.25
time to install sound board per PC (hours)	1	1	Y	1
time to install Itel software per PC (hours)	1	1	Y	1
time to install Audiotrix Phone per PC (hours)	2	2	Y	2
time to install Itel software for server Internet telephony apps.	2	2	Y	2
time to install Gateway Server (hours)	8	8	Y	8
time to install Gateway voice software per port	1.5	1.5	Y	1.5
time to install Gateway fax software per port	1.5	1.5	Y	1.5
time to install Dialogic Boards in server	1	1	Y	1
time to install fax modems in server	1	1	Y	1
time to install Desktop Ethernet Switch (hours)	4	4	Y	4
time to install Workgroup 10Base-T Hub	4	4	Y	4
Operations				

network operations				
SW/HW maint. (% of equipment costs)	20%	20%	Y	20%
additional support per employee for Internet telephony (min)	15	15	Y	15
additional hours per week of work	12.50	12.50	Y	12.50
hours per work week	40	40	Y	40
# of additional operations persons				0.3125
ops person's salary	\$50,000	\$50,000	Y	\$50,000
Cost of Capital Factors				
Debt Percent	30.0%	30.0%	Y	30.0%
Cost of Debt	9.0%	9.0%	Y	9.0%
Cost of Equity	17.9%	17.9%	Y	17.9%
Cost of Capital	15.2%	26.0%	Y	15.2%

Appendix C: Outcomes for Base Scenarios

Scenario A: Headset with microphone, individual software packages per PC		
Equipment	equipment	annualized
	cost	cost/mo.
Headset	\$1,312.50	\$36.52
Sound board	\$9,250.00	\$257.36
software	\$3,250.00	\$162.48
software for telecommuting	\$325.00	\$16.25
Subtotal for employee stations:	\$14,137.50	\$472.60
Replace Hub with a Switch	\$7,188.00	\$199.99
Gateway	\$14,830.00	\$515.76
Installation of Business Lines	\$400.00	\$9.56
Subtotal for infrastructure:	\$22,418.00	\$725.31
Total Equipment:	\$36,555.50	
Total ann. cost per month:	\$1,197.92	
Operations		
	annual	monthly
	cost	Cost
SW/HW Maintenance	\$2,875.00	\$239.58
Personnel	\$15,625.00	\$1,302.08
Business Lines	\$3,264.00	\$272.00
Annual Operations Cost:	\$18,500.00	
Monthly Operations Cost:	\$1,813.67	
Total Monthly Cost:	\$3,011.58	
total number of employees:	50	
Cost / employee / month:	\$60.23	

Scenario B: Headset with microphone, Internet telephony client software		
Equipment		
	cost	annualized
	installed	cost/mo.
Headset	\$1,312.50	\$36.52
Sound board	\$9,250.00	\$257.36
Internet telephony client software	\$2,450.00	\$122.49
software for telecommuting	\$325.00	\$16.25
Subtotal for employee station:	\$13,337.50	\$432.61
Replace Hub with a Switch	\$7,188.00	\$199.99
Gateway	\$14,830.00	\$515.76
Installation of Business Lines	\$400.00	\$9.56
Subtotal for infrastructure:	\$22,418.00	\$725.31
Total Equipment:	\$35,755.50	
Total ann. cost per month:	\$1,157.92	
Operations		
	annual	monthly
	cost	Cost
SW/HW Maintenance	\$2,779.01	\$231.58
Business Lines	\$3,264.00	\$272.00
Personnel	\$15,625.00	\$1,302.08
Total Operations Cost:	\$21,668.01	
Monthly Operations Cost:	\$1,805.67	
Total Monthly Cost:	\$2,963.59	
total number of employees	50	
Cost per employee per month	\$59.27	

Scenario C: Audiotrix Phone		
Equipment		
	cost	annualized
	installed	cost/mo.
Audiotrix Phone w/ software	\$22,300.00	\$620.44
software for telecommuting	\$325.00	\$16.25
Subtotal for employee stations:	\$22,625.00	\$636.69
Replace Hub with a Switch	\$7,188.00	\$199.99
Gateway	\$14,830.00	\$515.76
Installation of Business Lines	\$400.00	\$9.56
Subtotal for infrastructure:	\$22,418.00	\$725.31
Total Equipment:	\$45,043.00	
Total ann. cost per month:	\$1,362.00	
Operations		
	annual	monthly
	cost	Cost
SW/HW Maintenance	\$3,268.80	\$272.40
Business Lines	\$3,264.00	\$272.00
Personnel	\$15,625.00	\$1,302.08
Total Operations Cost:	\$22,157.80	
Monthly Operations Cost:	\$1,846.48	
Total Monthly Cost:	\$3,208.48	
total number of employees:	50	
Cost / employee / month:	\$64.17	

Appendix D: Erlang B Macros by Brett Leida

These functions were written by Brett Leida, RPCP-MIT. For the situation to size the number of lines for a business, the following substitutions were made:

c = number of business lines
p = load = avg. holding time * peak combined calls per hour

The functions that follow use an iterative approach to determine the value for c.

The following is the code, as written by Leida, for the Cost Model to Describe Internet Service Providers -- MIT 1997.

This module contains two functions used to size POP equipment. ErB uses the Erlang Loss formula to calculate the probability that a line will be blocked.

ErbSlv is a simple solver routine that uses ErB to find the number of modems or servers required given a blocking probability.

Note: ErbSlv returns an integer value and has an error factor of +/- 1

ErB(c,p) = prob. of blockage
c = number servers, modems, ...
p = load = % users that call during peak * avg holding time * no users

Function Fucn(1 As Integer) As Double

Fucn = 1 ^ 1 / 2

End Function

Function ErB(c As Integer, p As Double) As Double

Dim numerator As Double

Dim Series As Double

Dim Fcn As Double

Dim i As Integer

Series = 0

For i = 1 To c

Series = Series + i ^ (-0.5) * Exp(i * (1 + Log(p) - Log(i)) - Fucn(c))

Next i

ErB = Exp(Log(c ^ (-0.5)) + c * (1 + Log(p) - Log(c)) - Fucn(c) - Log(Exp(-Fucn(c)) + Series))

End Function

ErBSlv(blockprob, p) = c = number of servers, modems, ... needed to achieve blockprob
blockprob = prob. of blockage (val. normally returned by ErlangB function)
trafficload = % users that call during peak * avg holding time * no users

This simple solve routine assumes c is an integer and that an error of +- 1 for c is acceptable. The routine starts with setting c = trafficload.

```
Function ErBSlv(blockprob As Double, trafficload As Double) As Integer
Dim c As Integer
Dim oldc As Integer
Dim temp As Integer
Dim try As Double
Dim inc As Boolean
Dim dec As Boolean
,
try = 1
c = Abs(trafficload * (1 - blockprob))
inc = False
dec = False
oldc = temp = 0
While ((Abs(try - blockprob) > 0.3 * blockprob) And (Not (inc And dec)))
  try = ErB(c, trafficload)
  If try > blockprob Then
    c = c + 1
    inc = True
  ElseIf try < blockprob Then
    c = c - 1
    dec = True
  End If
Wend
ErBSlv = c
End Function
```

**Appendix E: Internet Telephony Consortium European Regulatory Task
Force Comment to the European Commission Concerning the Status of
Voice on the Internet under Directive 90/388/EEC**



INTERNET TELEPHONY INTEROPERABILITY CONSORTIUM
Massachusetts Institute of Technology

**Comment to the European Commission Concerning the Status of Voice on the Internet
under Directive 90/388/EEC**

Submitted by the Internet Telephony Consortium European Regulatory Task Force⁹¹

Summary

The Internet Telephony Consortium European Regulatory Task Force submits this comment in support of the European Commission and its position not to regulate Internet telephony at this time. The Task Force believes that Internet telephony over the public Internet cannot provide real-time voice communication at this time and subsequently falls into the liberalised area. Internet telephony can be seen as a technology that can promote interoperability between the Internet and public telecommunications networks. Furthermore, the applications of Internet telephony that may satisfy the Commission's criteria for voice telephony should be viewed as insignificant threats compared to the benefits. Benefits can arise from the utilization of this technology to develop complementary technologies required to support effective and useful real-time multimedia services over the Internet. Premature regulation of Internet telephony would hinder innovation in this field as well as hinder innovation for the Internet and the public telecommunications network.

*The Internet Telephony Consortium*⁹²

The Internet Telephony Consortium (ITC) is a group that examines the technical, economic, strategic, and policy issues that arise from the convergence of telecommunications and the Internet. The ITC is comprised of Member Companies and academic researchers who represent the various interests associated with the Internet, Internet telephony and the telecommunications industries. The ITC seeks to be a neutral forum for members to discuss these issues and to benefit from cross-industry communication. The long term goal of the

⁹¹ The Internet Telephony Consortium European Regulatory Task Force is a group formed specifically to respond to the Notice by the Commission concerning the status of voice on the Internet under Directive 90/388/EEC. The views expressed in this comment represent the views of the members of this Task Force and should not be construed as representing the position of the ITC, member companies or individuals not participating on the Task Force, or the Massachusetts Institute of Technology. Member companies participating on this Task Force include Hewlett-Packard, Mediatrix Peripherals, Inc., Natural Microsystems, NetSpeak Corp., Nokia, Telecom Italia and Telia.

⁹² More information about the ITC and its goals can be found at its web site <http://itel.mit.edu/>.

ITC is to enable the growth of new forms of mediated, integrated multimedia communication spanning the Internet and the telecommunications infrastructures.

A core concept of the ITC is the collaboration with member companies to explore the opportunities to increase the interoperability between the Internet and the public telecommunications network. The ITC sees Internet telephony as a technology that can enable applications and services to work between the Internet and the public telecommunications network. The interoperability provided by Internet telephony is seen as a means of complementing and enhancing the currently available public voice telephony services.

Internet Telephony

Internet telephony was developed originally to provide a functionally viable methodology for enabling useful interactive voice communications over the existing IP based Internet. The process generally requires the use of personal computers (PCs) with the same application software running on the originating and receiving terminals. Both PCs need to be connected to an Internet Service Provider (ISP), and be equipped with a sound card (multimedia enabled), a microphone and speakers. This form of connectivity using PCs has been a primary focus for the development of Internet telephony technology. This extended PC connectivity represents the transport mode that gains the greatest advantage from the single bandwidth-managed, multimedia, distributed network fabric made possible through the application of Internet telephony technology.

The development of voice communication capabilities using the Internet protocol (IP) over the Internet has progressed to where these capabilities are more accurately viewed as IP telephony than as Internet telephony. The IP telephony capabilities, which are only now becoming widespread, have shown considerable potential for addressing the various challenges of modern telephony requirements that are difficult to meet using only the circuit-switching techniques of conventional telephony. The areas IP telephony addresses relate to such things as: delivery of incoming calls from the Internet to existing call centers; providing virtual office capabilities for at-home workers (telecommuters); providing mobile desk-top capabilities for traveling employees; multimedia enabling of enterprise Wide Area Networks; and the provisioning of cost efficient and functionally effective disaster recovery plans.

A key element in making effective use of the emerging IP telephony technology is the development and use of gateways that bridge the IP environment of the Internet and the circuit-switched environment of the public telecommunications network. Such gateways are devices that make it possible to construct application specific network structures that provide for real-time two-way communication between circuit-switching and packet-switching technologies to create an integrated networking fabric. Enabling interoperability between the public telecommunications network and the Internet, as can be done with gateways, is one of the original objectives in the formation of the ITC.

The public Internet is not a controlled network environment. IP technology used on the Internet uses non-deterministic switching (datagrams) which offers little potential for approximating real-time voice connectivity in that environment. As a consequence, Internet telephony over the public Internet is not at this time a serious candidate for direct competition in the field of voice telephony. By the definition of “voice telephony” used by this

commission, due to its lack of real-time capabilities over the public Internet, IP telephony would fall into the liberalised area.

Internet Telephony and Regulation

While Internet telephony has been influential technology, its market niche in the telecommunications industry has been as a consumer related “Chat” product, with an appeal similar to that of amateur (HAM) radio. While Internet telephony software is generally available to anyone who wishes to purchase and use it, the deployment of gateways has been relatively limited. The most immediate potential for gateways lies in expanding commerce by providing direct and immediate access from the World Wide Web to existing businesses that operate in the PSTN environment. The number of visitors to the WWW is growing dramatically, and represents an enormous potential market that is independent of geography.

The near term potential of Internet telephony lies in closed, private networks and in the provision of substantial value-added capabilities to conventional circuit-switched networks. Any regulation limiting the use of gateways in applications where the non-real-time characteristics of Internet telephony are adequate can severely limit the availability of working development platforms. Premature regulations could significantly hamper the process of introducing IP-based enhancements to public network-based systems. Regulation will also slow the development of new networks to support a full range of multimedia communications on a single network fabric.

Internet telephony is at a point where it can be favorably compared to traditional voice telephony for serving potential customers on the Web. Both the technology and the market for Internet telephony are still immature and need to continue to be developed to reach their potential. Regulation of Internet telephony by the entire European Union could significantly hinder the innovation that is currently taking place. Regulation by individual Member States would only cause the domestic telecommunications industry to suffer as the industry in other States embraces and develops Internet telephony. Additionally, even if Internet telephony is regulated by either the entire Union or a few Member States, voice over the Internet may still be in use by some alternative technological method. Regulation of Internet telephony at this time would be an ineffective and inappropriate response to this developing technology and market.

The further development of Internet telephony also has the potential to affect another industry—the telecommunications industry. Internet telephony is an emerging technology with a great potential to be a positive influence on traditional telephony. Internet telephony could be a competitive alternative to the traditional voice telephony market. In such a competitive state, both industries would have to innovate and improve to remain competitive. Moreover, it can be seen as an additional opportunity to accelerate the move toward cost-based tariffs especially in countries where tariff rebalancing is still under way. If the desire is to have a competitive telecommunications industry, introduction of an alternative method of voice transport would be wise to allow to occur. Also, with the trend of deregulation and the opening of telecommunication markets to competition, it would seem inappropriate to advocate increased regulation. By allowing the continued innovation and development of Internet telephony, a true alternative and a more competitive market are a little bit closer to realisation. Creating constraints on the development of Internet telephony at this time will

only stifle innovation in Internet telephony technology and applications but also has the potential to stifle innovation in traditional telephony as well.

Conclusion

Internet telephony is an emerging and dynamic technology that has great potential to change the way people communicate. It is a technology that promotes innovation and not only in the Internet but in complementary technologies and neighboring sectors, mainly in the telecommunications sector. To regulate Internet telephony at this time, would harm its development, as well as the development of other areas of communication like traditional telephony. If in the future, the Union does choose to regulate Internet telephony, it must keep in mind that the Internet is a dynamic field and that traditional regulatory models based on voice telephony are likely to be inappropriate.